

Washer-Extractor



Model	SI	110
	SI	135
	SI	200
	SI	275
	SI	300

SI Series Parts Manual



B&C Technologies Inc.
Panama City, FL
TEL. (850) 249-2222
FAX. (850) 249-2226
www.bandetech.com

4-March-2013

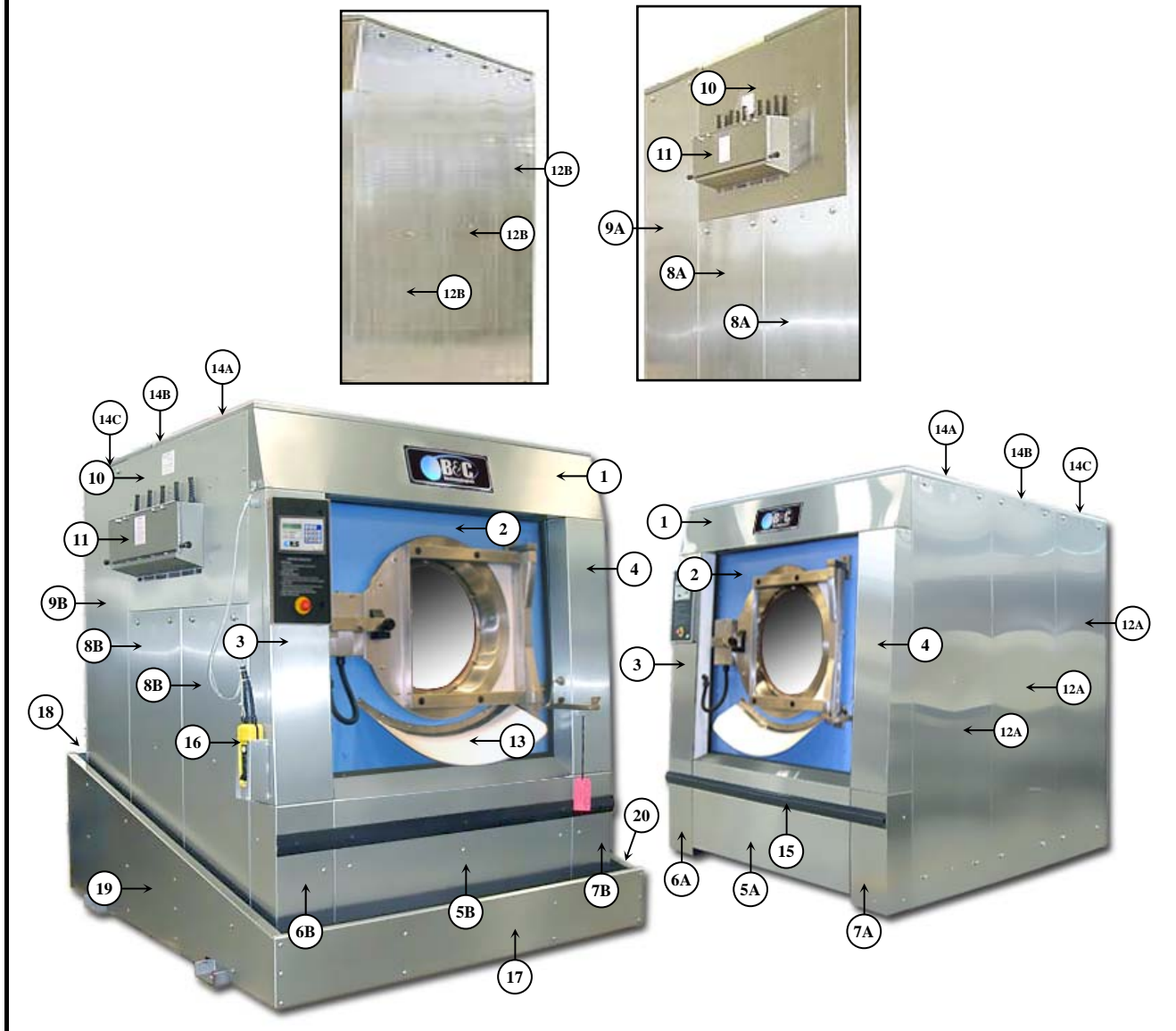

Item	Part No.					Qty.	Description
	110 lb.	135 lb.	200 lb.	275 lb.	300 lb.		
1	A1-S110-001	A1-S135-001	A1-S200-001	A1-SSII-086	A1-SSII-086	1	Front panel assembly, Top
2	A1-S110-002	A1-S135-002	A1-S200-002	A1-SSII-087	A1-SSII-087	1	Front panel cabinet (Color PU:0121)
3	A1-S110-003	A1-S135-003	A1-S200-003	A1-SSII-088	A1-SSII-088	1	Right column, Top
4	A1-S110-004	A1-S135-004	A1-S200-004	A1-SSII-089	A1-SSII-089	1	Left Column, Top
5A	A1-S110-070	A1-S135-070	A1-S200-070	A1-SSII-090	A1-SSII-090	1	Front panel assembly, Lower (Non tilt)
5B	A1-S110-005	A1-S135-005	A1-S200-005	A1-SSII-091	A1-SSII-091	1	Front panel assembly, Lower (Tilt)
6A	A1-S110-071	A1-S135-071	A1-S200-071	A1-SSII-092	A1-SSII-092	1	Right column, Lower (Non tilt)
6B	A1-S110-006	A1-S135-006	A1-S200-006	A1-SSII-093	A1-SSII-093	1	Right column, Lower (Tilt)
7A	A1-S110-072	A1-S135-072	A1-S200-072	A1-SSII-094	A1-SSII-094	1	Left Column, Lower (Non tilt)
7B	A1-S110-007	A1-S135-007	A1-S200-007	A1-SSII-095	A1-SSII-095	1	Left Column, Lower (Tilt)
8A	A1-S110-073	A1-S135-073	A1-S200-073	A1-S275-073	A1-S300-073	2	Right lower panel assembly, Left (Non tilt)
8B	A1-S110-008	A1-S135-008	A1-S200-008	A1-S275-008	A1-S300-008	2	Right lower panel assembly, Left (Tilt)
9A	A1-S110-074	A1-S135-074	A1-S200-074	A1-S275-074	A1-S300-074	1	Right lower panel assembly, Right (Non tilt)
9B	A1-S110-009	A1-S135-009	A1-S200-009	A1-S275-009	A1-S300-009	1	Right lower panel assembly, Right (Tilt)
10	A1-S110-010	A1-S135-010	A1-S200-010	A1-S275-010	A1-S300-010	1	Right panel assembly, Top
11	A1-S110-011	A1-S135-011	A1-S200-011	A1-S275-011	A1-S300-011	1	Supply dispenser body

Item	Part No.					Qty.	Description
	110 lb.	135 lb.	200 lb.	275 lb.	300 lb.		
12A	A1-S110-075	A1-S135-075	A1-S200-075	A1-S275-075	A1-S300-075	3	Left panel assembly (Non tilt)
12B	A1-S110-012	A1-S135-012	A1-S200-012	A1-S275-012	A1-S300-012	3	Left panel assembly (Tilt)
13	A1-S110-013	A1-S135-013	A1-S200-013	A1-SSII-113	A1-SSII-113	1	Cone, Receive cloth cleaned
14A	A1-S110-036	A1-S135-036	A1-S200-036	A1-S275-036	A1-S300-036	1	Top panel assembly A
14B	A1-S110-076	A1-S135-076	A1-S200-076	A1-S275-076	A1-S300-076	1	Top panel assembly B
14C	-	-	-	A1-S275-077	A1-S300-077	1	Top panel assembly C
15	A0-A038-002	A0-A038-002	A0-A038-002	A0-A038-002	A0-A038-002	1	Guard, Bumper-Base
	A0-A038-003	A0-A038-003	A0-A038-003	A0-A038-003	A0-A038-003	1	Guard, Bumper-Insert
16	A0-E032-031	A0-E032-031	A0-E032-031	A0-E032-031	A0-E032-031	1	Pendant control stations
	A0-E032-020	A0-E032-020	A0-E032-020	A0-E032-020	A0-E032-020	1	Remote Control 4
	A0-E032-019	A0-E032-019	A0-E032-019	A0-E032-019	A0-E032-019	1	Remote Control 6
17	A1-S110-078	A1-S135-078	A1-S200-078	A1-SSII-107	A1-SSII-107	1	Tilt skirt, Front (1 way tilt)
	A1-S110-079	A1-S135-079	A1-S200-079	A1-SSII-108	A1-SSII-108	1	Tilt skirt, Front (2 way tilt)
18	A1-S110-080	A1-S135-080	A1-S200-080	A1-SSII-109	A1-SSII-109	1	Tilt skirt, Rear (1 way tilt, 1 drain)
	A1-S110-081	A1-S135-081	A1-S200-081	A1-SSII-110	A1-SSII-110	1	Tilt skirt, Rear (1 way tilt, 2 drain)
	A1-S110-082	A1-S135-082	A1-S200-082	A1-SSII-111	A1-SSII-111	1	Tilt skirt, Rear (2 way tilt, 1 drain)
	A1-S110-083	A1-S135-083	A1-S200-083	A1-SSII-112	A1-SSII-112	1	Tilt skirt, Rear (2 way tilt, 2 drain)
19	A1-S110-084	A1-S135-084	A1-S200-084	A1-S275-084	A1-S300-084	1	Tilt skirt, Right (1 way tilt)
	A1-S110-085	A1-S135-085	A1-S200-085	A1-S275-085	A1-S300-085	1	Tilt skirt, Right (2 way tilt)
20	A1-S110-086	A1-S135-086	A1-S200-086	A1-S275-086	A1-S300-086	1	Tilt skirt, Left (1 way tilt)
	A1-S110-087	A1-S135-087	A1-S200-087	A1-S275-087	A1-S300-087	1	Tilt skirt, Left (2 way tilt)

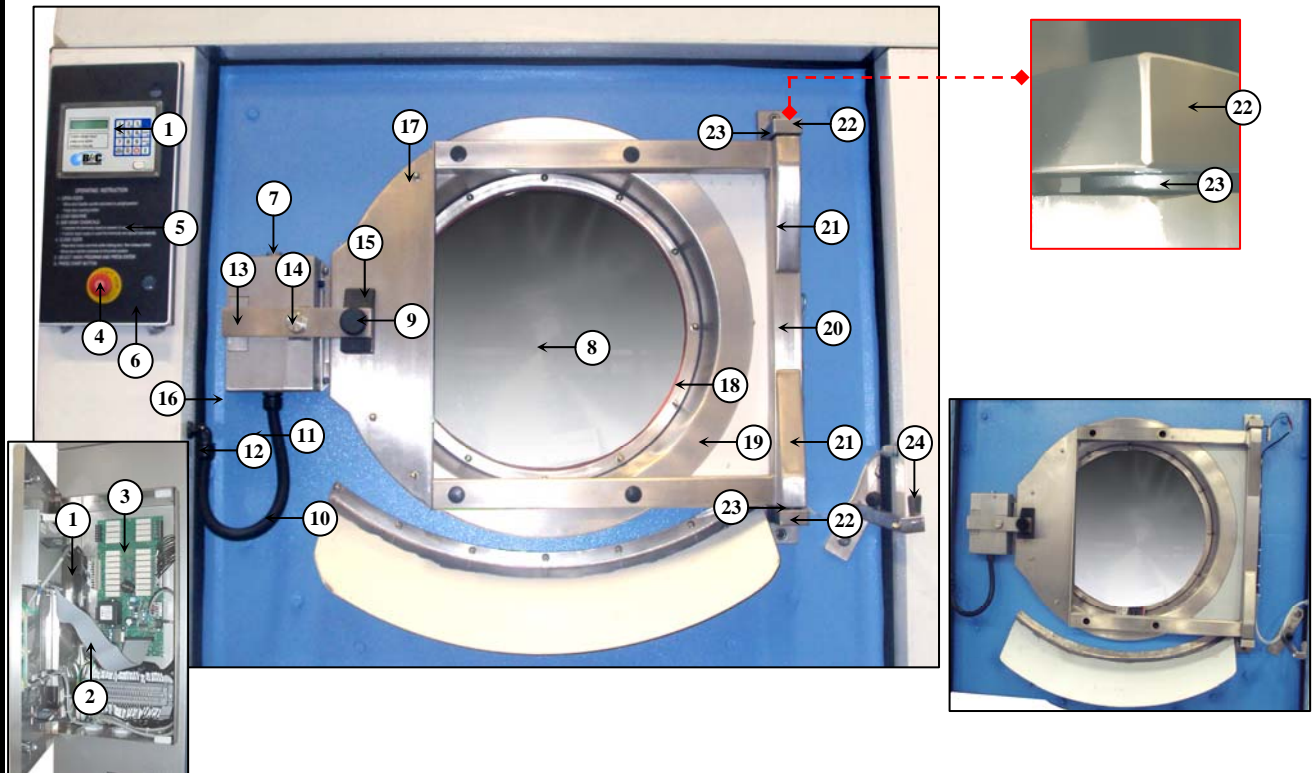

Item	Part No.					Qty.	Description
	110 lb.	135 lb.	200 lb.	275 lb.	300 lb.		
1	A0-E007-001	A0-E007-001	A0-E007-001	A0-E007-001	A0-E007-001	1	EL6, CPU Unit
2	A0-E007-002	A0-E007-002	A0-E007-002	A0-E007-002	A0-E007-002	1	EL6, Cable ribbon 40 pin
3	A0-E007-003	A0-E007-003	A0-E007-003	A0-E007-003	A0-E007-003	1	EL6, Output board
4	A0-E032-018	A0-E032-018	A0-E032-018	A0-E032-018	A0-E032-018	1	Emergency stop
5	A0-A090-025	A0-A090-025	A0-A090-025	A0-A090-025	A0-A090-025	1	Sticker, Operating Instruction
6	A1-SSII-081	A1-SSII-081	A1-SSII-081	A1-SSII-081	A1-SSII-081	1	Box, Control mounting front right
	A1-SSII-084	A1-SSII-084	A1-SSII-084	A1-SSII-084	A1-SSII-084	1	Cover, Control mounting front right
7	A0-E032-003	A0-E032-003	A0-E032-003	A0-E032-003	A0-E032-003	1	Push button switch
8	A0-A003-001	A0-A003-002	A0-A003-002	A0-A003-003	A0-A003-003	1	Door glass
9	A0-A086-001	A0-A086-001	A0-A086-001	A0-A086-001	A0-A086-001	1	Door handle knob
10	A0-A001-021	A0-A001-021	A0-A001-021	A0-A001-021	A0-A001-021	1	Flexible conduit
11	A0-A028-008	A0-A028-008	A0-A028-008	A0-A028-008	A0-A028-008	1	Connector Straight
12	A0-A028-009	A0-A028-009	A0-A028-009	A0-A028-009	A0-A028-009	1	Connector Elbow
13	A1-SSI2-007	A1-SSI2-007	A1-SSI2-007	A1-SSI2-007	A1-SSI2-007	1	Door Lock Swing Arm Latch (Std)
14	A1-SSII-022	A1-SSII-022	A1-SSII-022	A1-SSII-022	A1-SSII-022	1	Shoulder Bolt
15	A1-SSII-018	A1-SSII-018	A1-SSII-018	A1-SSII-018	A1-SSII-018	1	Slide Door Lock (Std)
16	A1-SSI2-004	A1-SSI2-004	A1-SSI2-004	A1-SSI2-004	A1-SSI2-004	1	Door Lock Cover (Std)
17	A1-S110-021	A1-SSII-020	A1-SSII-020	A1-SSII-021	A1-SSII-021	1	Door Plate (Std)
18	A0-A001-008	A0-A001-009	A0-A001-009	A0-A001-010	A0-A001-010	1	Door gasket
	A1-S110-051	A1-SSII-014	A1-SSII-014	A1-SSII-015	A1-SSII-015	1	Retaining Ring Glass
19	A1-S110-050	A1-SSII-012	A1-SSII-012	A1-SSII-013	A1-SSII-013	1	Door Tub
20	A1-S110-048	A1-SSII-008	A1-SSII-008	A1-SSII-009	A1-SSII-009	1	Door Mounting Frame
21	-	A1-SSII-010	A1-SSII-010	A1-SSII-010	A1-SSII-010	2	Hinge Pin Mounting (Std)
22	A1-SSII-144	A1-SSII-016	A1-SSII-016	A1-SSII-016	A1-SSII-016	2	Door Hinge Bracket (Std)
23	A0-A028-008	A0-A028-008	A0-A028-008	A0-A028-008	A0-A028-008	2	Connector Straight
24	A1-S110-047	A1-SSII-060	A1-SSII-060	A1-SSII-061	A1-SSII-061	1	Door stopper

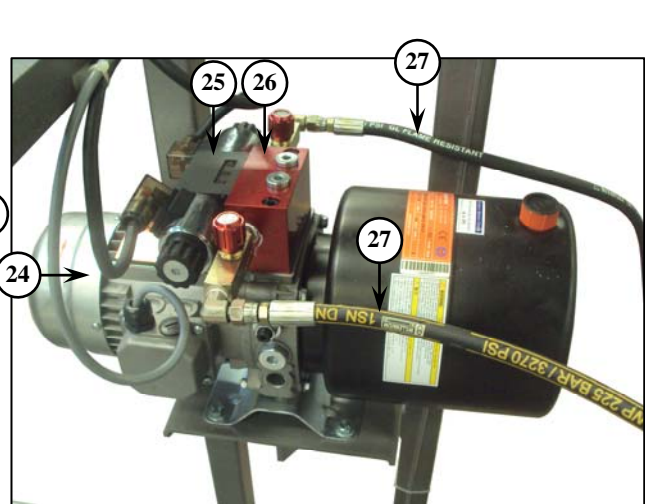
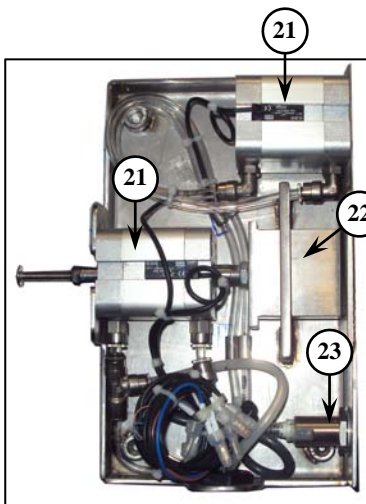
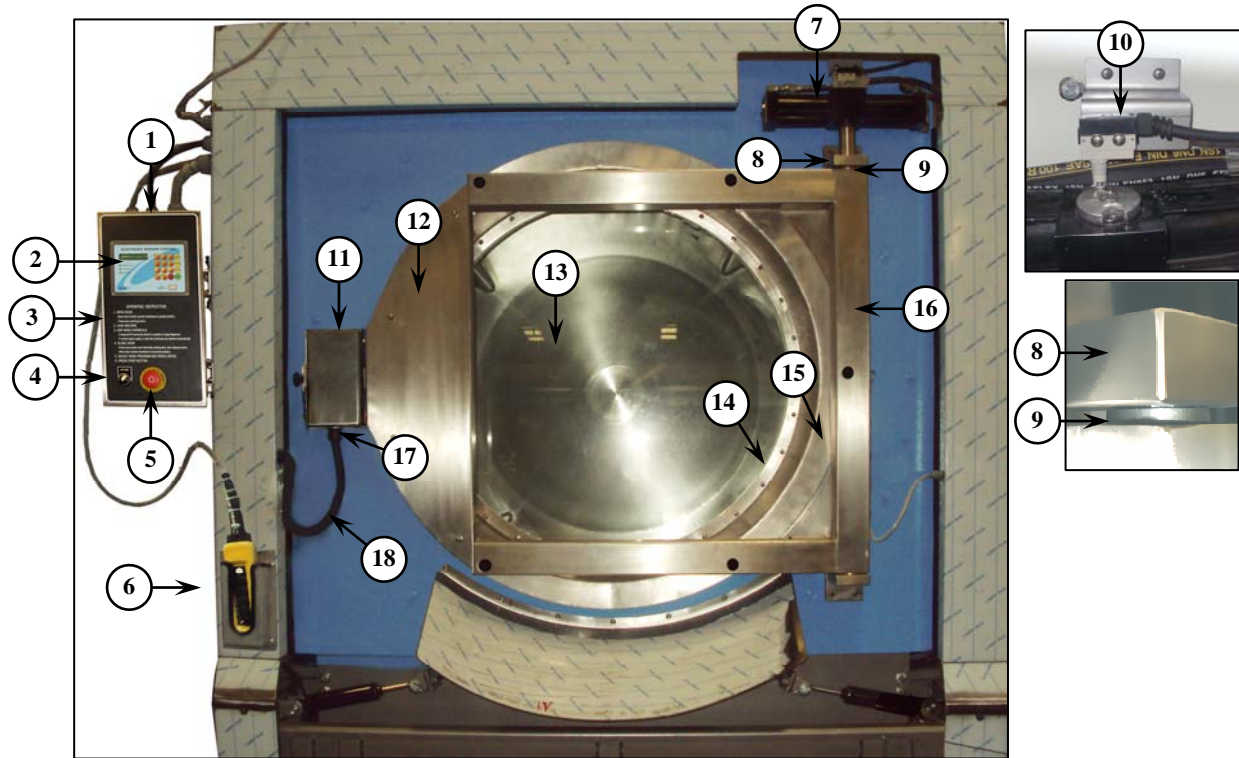

Item	Part No.					Qty.	Description
	110 lb.	135 lb.	200 lb.	275 lb.	300 lb.		
1	-	-	-	A1-SS11-081	-	1	Box, Control mounting front right
	-	-	-	A1-SS11-084	-	1	Cover, Control mounting front right
2	-	-	-	A0-E007-001	-	1	WC01, CUP Unit
3	-	-	-	A0-A090-005	-	1	Sticker, Operating instruction
4	-	-	-	A0-E032-073	-	1	Selector Switch Actuator (Black/white)
5	-	-	-	A0-E032-018	-	1	Emergency stop
6	-	-	-	A0-E032-031	-	1	Pendant control stations
	-	-	-	A0-E032-020	-	1	Remote Control 4
	-	-	-	A0-E032-019	-	1	Remote Control 6
7	-	-	-	A1-S450-082	-	1	Door hinge bracket
8	-	-	-	A0-A028-008	-	1	Connector straight
9	-	-	-	A0-A028-008	-	2	Connector straight

Item	Part No.					Qty.	Description
	110 lb.	135 lb.	200 lb.	275 lb.	300 lb.		
10	-	-	-	A0-E011-019	-	1	Limit Switch SHL-Q2255
11	-	-	-	A1-S450-078	-	1	Door lock cover
12	-	-	-	A1-S450-079	-	1	Door plate
13	-	-	-	A0-A003-020	-	1	Door glass
14	-	-	-	A1-S450-080	-	1	Retaining ring glass
15	-	-	-	A1-S450-081	-	1	Door tub
16	-	-	-	A1-S450-083	-	1	Door mounting frame
17	-	-	-	A0-A028-008	-	1	Connector straight
18	-	-	-	A0-A001-021	-	1	Flexible conduit
19	-	-	-	A0-E007-003	-	1	WC01, Output board
20	-	-	-	A0-E007-002	-	1	WC01, Cable ribbon 40 pin
21	-	-	-	A0-P003-040	-	2	Air cylinder
22	-	-	-	A1-SS11-040	-	1	Lock pin flat
23	-	-	-	A0-TSE01-219	-	1	Proximity S.W. 24VAC.
24	-	-	-	A0-TSAN01-233	-	1	Hydraulic power packs
25	-	-	-	A0-TSEN01-1460	-	1	Coil for HD-4WE6E , 24 VDC
26	-	-	-	A0-TSPN01-001	-	1	Vale hydraulic
27	-	-	-	A0-TSP01-097	-	2	Hydraulic Pipe

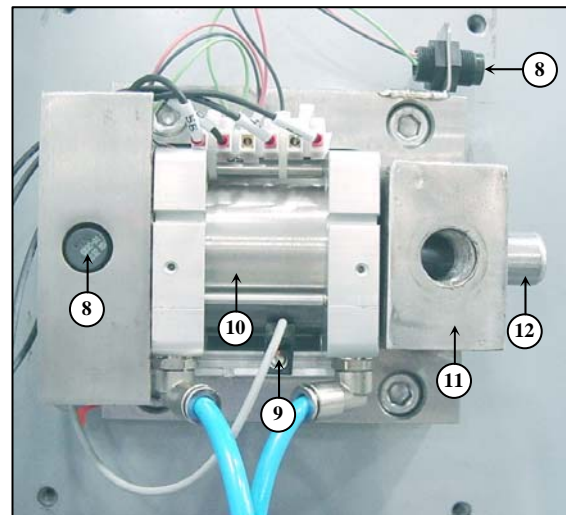
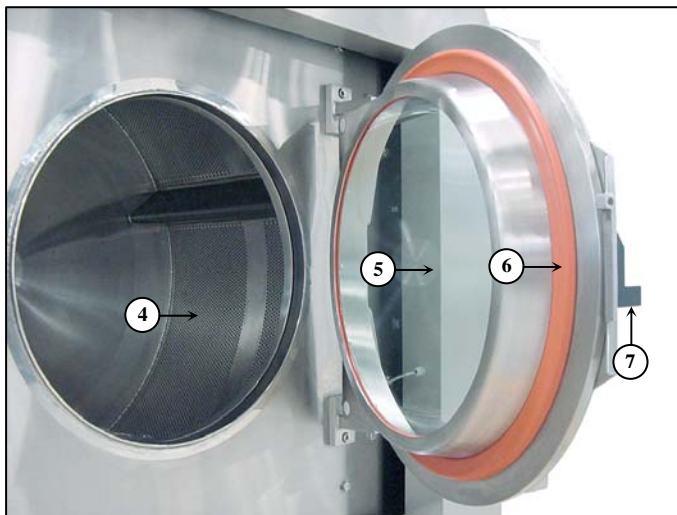
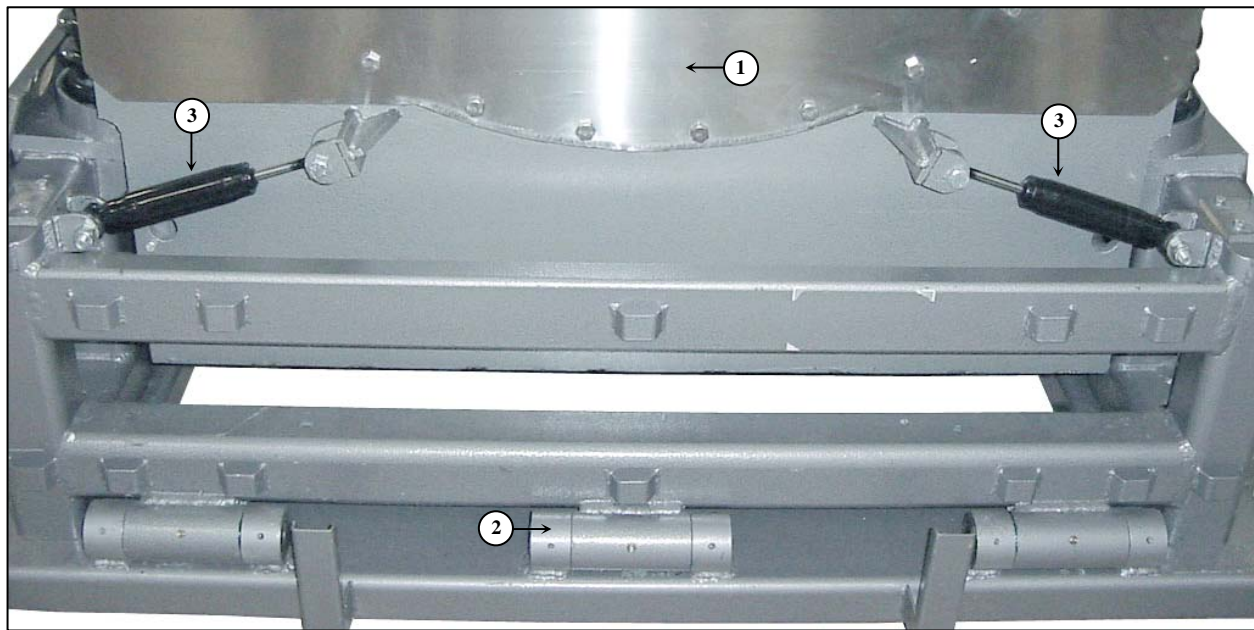

Item	Part No.					Qty.	Description
	110 lb.	135 lb.	200 lb.	275 lb.	300 lb.		
1	A1-S110-002	A1-S135-002	A1-S200-002	A1-SS11-087	A1-SS11-087	1	Front panel cabinet
2	A1-S110-027	A1-SS11-129	A1-SS11-129	A1-SS11-129	A1-SS11-129	3	Hinge
3	A0-A031-120	A0-A031-120	A0-A031-120	A0-A031-120	A0-A031-120	2	Medium shock absorber
4	A1-S110-029	A1-S135-029	A1-S200-029	A1-S275-029	A1-S300-029	1	Basket stainless steel
5	A0-A003-001	A0-A003-002	A0-A003-002	A0-A003-003	A0-A003-003	1	Door glass
6	A0-A001-008	A0-A001-009	A0-A001-009	A0-A001-010	A0-A001-010	1	Door gasket silicone orange
7	A1-SS11-018	A1-SS11-018	A1-SS11-018	A1-SS11-018	A1-SS11-018	1	Slide Door Lock (Std)
8	A0-E014-008	A0-E014-008	A0-E014-008	A0-E014-008	A0-E014-008	2	Proximity switch
9	A0-E014-006	A0-E014-006	A0-E014-006	A0-E014-006	A0-E014-006	1	Sensor for air cylinder door lock
10	A0-P003-007	A0-P003-007	A0-P003-007	A0-P003-007	A0-P003-007	1	Air Cylinder, Lock (Std)
11	A1-SS12-006	A1-SS12-006	A1-SS12-006	A1-SS12-006	A1-SS12-006	1	Door Lock Mounting (Std)
12	A1-SS11-041	A1-SS11-041	A1-SS11-041	A1-SS11-041	A1-SS11-041	1	Lock Pin Head (Round) (Std)

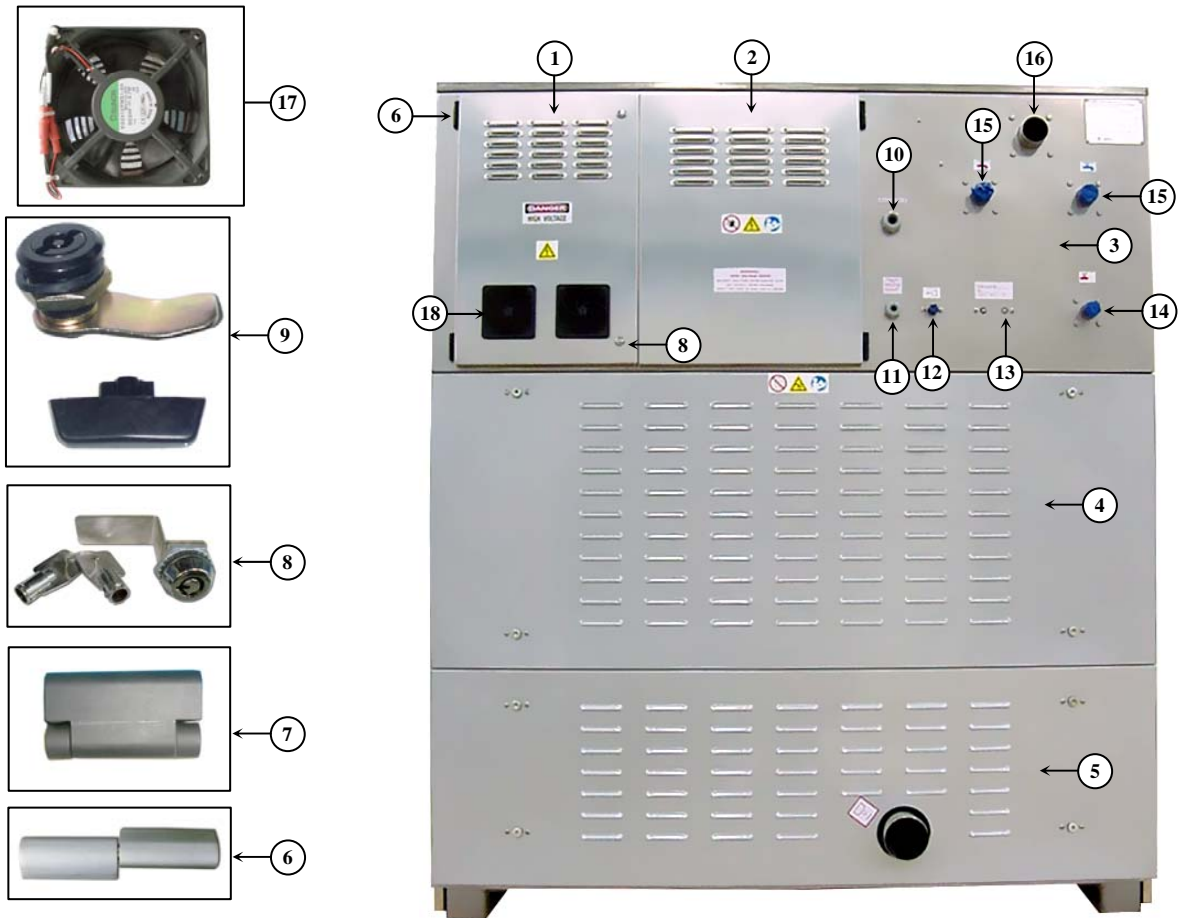

Item	Part No.					Qty.	Description
	110 lb.	135 lb.	200 lb.	275 lb.	300 lb.		
1	A1-S110-015	A1-S135-015	A1-S200-015	A1-SSII-117	A1-SSII-117	1	Door control, Left
2	A1-S110-016	A1-S135-016	A1-S200-016	A1-SSII-118	A1-SSII-118	1	Door control, Right
3	A1-S110-017	A1-S135-017	A1-S200-017	A1-S275-017	A1-S300-017	1	Rear panel, Top
4	A1-S110-018	A1-S135-018	A1-S200-018	A1-SSII-114	A1-SSII-114	1	Rear panel assembly, Middle
5	A1-S110-019	A1-S135-019	A1-S200-019	A1-SSII-115	A1-SSII-115	1	Rear panel assembly, Lower (1 drain)
	A1-S110-088	A1-S135-088	A1-S200-088	A1-SSII-116	A1-SSII-116	1	Rear panel assembly, Lower (2 drain)
6	A0-A029-001	A0-A029-001	A0-A029-001	A0-A029-001	A0-A029-001	4	Hing, Nylon, Liftoff
7	A0-A029-005	A0-A029-005	A0-A029-005	A0-A029-005	A0-A029-005	4	Hinge, Off set panel door
8	A0-A013-001	A0-A013-001	A0-A013-001	A0-A013-001	A0-A013-001	2	Door lock
9	A0-A013-002	A0-A013-002	A0-A013-002	A0-A013-002	A0-A013-002	2	Door lock
10	A0-A028-004	A0-A028-004	A0-A028-004	A0-A028-004	A0-A028-004	1	Cable gland + Locknut
11	A0-A028-003	A0-A028-003	A0-A028-003	A0-A028-003	A0-A028-003	1	Cable gland + Locknut
12	A1-SSI2-025	A1-SSI2-025	A1-SSI2-025	A1-SSI2-025	A1-SSI2-025	1	Air inlet, 3/8"
13	A0-A024-004	A0-A024-004	A0-A024-004	A0-A024-004	A0-A024-004	1	Grease fitting unit (Brass)
14	A1-SSI2-029	A1-SSI2-029	A1-SSI2-021	A1-SSI2-021	A1-SSI2-021	1	Steam inlet (Std)
	-	A1-SSI2-021	-	-	-	1	Steam inlet (Option)
15	A1-SSI2-026	A1-SSI2-026	A1-SSI2-027	A1-SSI2-027	A1-SSI2-028	1	Cold-Hot water inlet (Std)
	-	A1-SSI2-027	-	A1-SSI2-028	-	1	Cold-Hot water inlet (Option)
16	A1-SSII-051	A1-SSII-052	A1-SSII-052	A1-SSII-053	A1-SSII-053	1	Air vent
17	A0-E012-008	A0-E012-008	A0-E012-008	A0-E012-008	A0-E012-008	2	Cooling fan
18	A0-E012-009	A0-E012-009	A0-E012-009	A0-E012-009	A0-E012-009	2	Fan filter

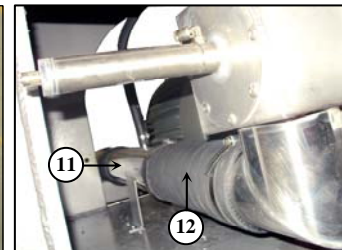
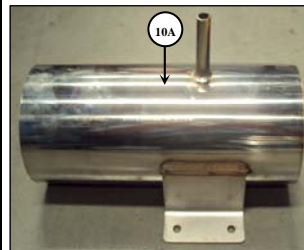
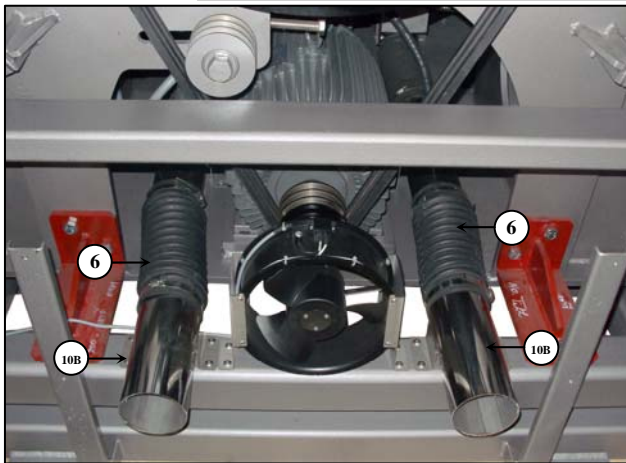
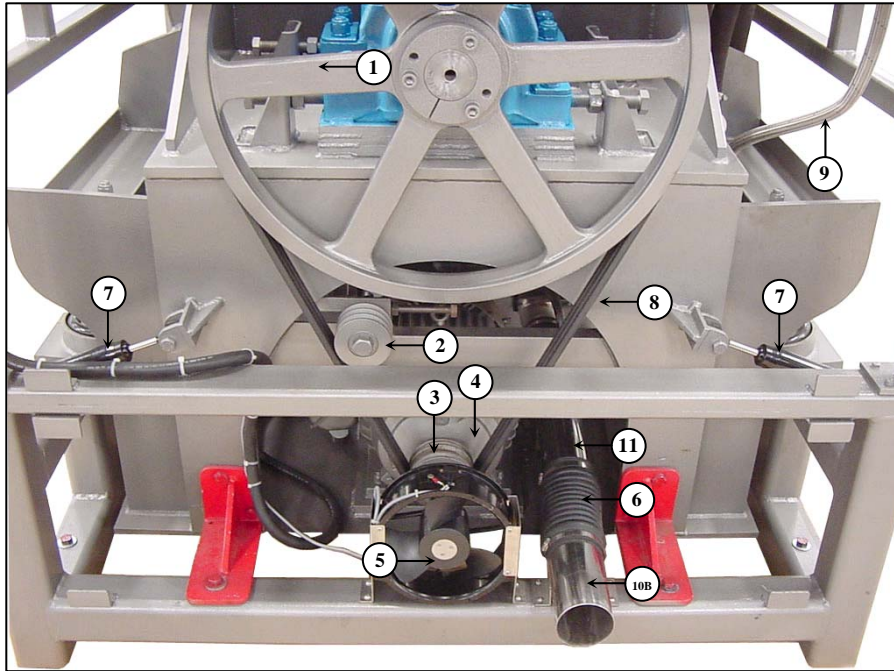

Item	Part No.					Qty.	Description
	110 lb.	135 lb.	200 lb.	275 lb.	300 lb.		
1	A0-M008-019	A0-M008-019	A0-M008-021	A0-M008-023	A0-M008-023	1	Basket pulley
	A0-M009-023	A0-M009-027	A0-M009-028	A0-M009-030	A0-M009-030	1	Basket pulley bushing
	A0-A069-006	A0-A069-006	A0-A069-006	A0-A069-006	A0-A069-006	3	Socket head screw
2	A0-M008-082	A0-M008-082	A0-M008-083	A0-M008-084	A0-M008-084	1	Pulley, adjusting belt
	A0-A004-108	A0-A004-108	A0-A004-107	A0-A004-107	A0-A004-107	2	Ball bearing
3	A0-M008-020	A0-M008-020	A0-M008-080	A0-M008-081	A0-M008-081	1	Motor pulley
	A0-M009-024	A0-M009-024	A0-M009-068	A0-M009-031	A0-M009-031	1	Motor pulley bushing "US Motor"
	A0-M009-026	A0-M009-026	-	A0-M009-032	-	1	Motor pulley bushing "Teco Motor"
	A0-A069-003	A0-M009-003	A0-M009-003	A0-M009-003	A0-M009-003	3	Socket head screw
4	A0-E008-220	A0-E008-219	A0-E008-218	A0-E008-216	A0-E008-216	1	Motor "Teco" (Std)
	-	A0-E008-854	A0-E008-218	A0-E008-217	A0-E008-217	1	Motor "Teco" (Option)
	A0-E008-003	A0-E008-004	A0-E008-005	A0-E008-006	A0-E008-006	1	Motor "US" (Option)
	A0-E008-120	A0-E008-121	A0-E008-122	A0-E008-123	A0-E008-123	1	Motor "Toshiba" (Option)
5	A0-E012-005	A0-E012-005	A0-E012-005	A0-E012-005	A0-E012-005	1	Cooling fan (110-120VAC, 50/60 Hz)
6	A0-A018-034	A0-A018-034	A0-A018-034	A0-A018-034	A0-A018-034	1,2	Rubber hose (Qty. 2 for 2 Drain)

Item	Part No.					Qty.	Description
	110 lb.	135 lb.	200 lb.	275 lb.	300 lb.		
7	A0-A031-120	A0-A031-120	A0-A031-120	A0-A031-120	A0-A031-120	2	Medium shock absorber
8	A0-A002-020	A0-A002-021	A0-A002-022	A0-A002-024	A0-A002-024	2,3,4	V-Belt
			A0-A002-128			3	V- Belt
9	A0-A017-099	A0-A017-099	A0-A017-064	A0-A017-097	A0-A017-097	1	Flexible (For Type Steam)
10A	-	-	-	A1-SSII-120	A1-SSII-120	1,2	Drain outlet 4"x200mm., Rear Non tilt (Qty. 2 for 2 Drain)
	-	-	-	A1-SSII-133	A1-SSII-133	1,2	Drain outlet 4"x250mm., Rear 1 tilt (Qty. 2 for 2 Drain)
	-	-	-	A1-SSII-134	A1-SSII-134	1,2	Drain outlet 4"x300mm., Rear 2 tilt (Qty. 2 for 2 Drain)
10B	A1-SSII-135	A1-SSII-135	A1-SSII-135	-	-	1,2	Drain outlet 4"x200mm., Rear Non tilt (Qty. 2 for 2 Drain)
	A1-SSII-136	A1-SSII-136	A1-SSII-136	-	-	1,2	Drain outlet 4"x250mm., Rear 1 tilt (Qty. 2 for 2 Drain)
	A1-SSII-137	A1-SSII-137	A1-SSII-137	-	-	1,2	Drain outlet 4"x300mm., Rear 2 tilt (Qty. 2 for 2 Drain)
11	A1-SSII-132	A1-SSII-138	A1-SSII-139	A1-SSII-140	A1-SSII-140	1,2	Drain outlet Medium (Qty. 2 for 2 Drain)
12	A0-A018-044	A0-A018-044	A0-A018-044	A0-A018-044	A0-A018-044	1,2	Hose, Connection Drain 4"x200mm. (Qty. 2 for 2 Drain)

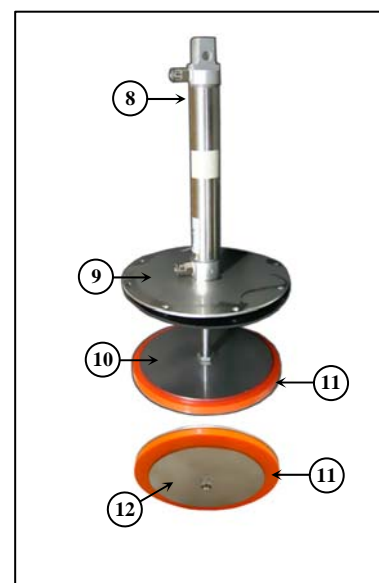
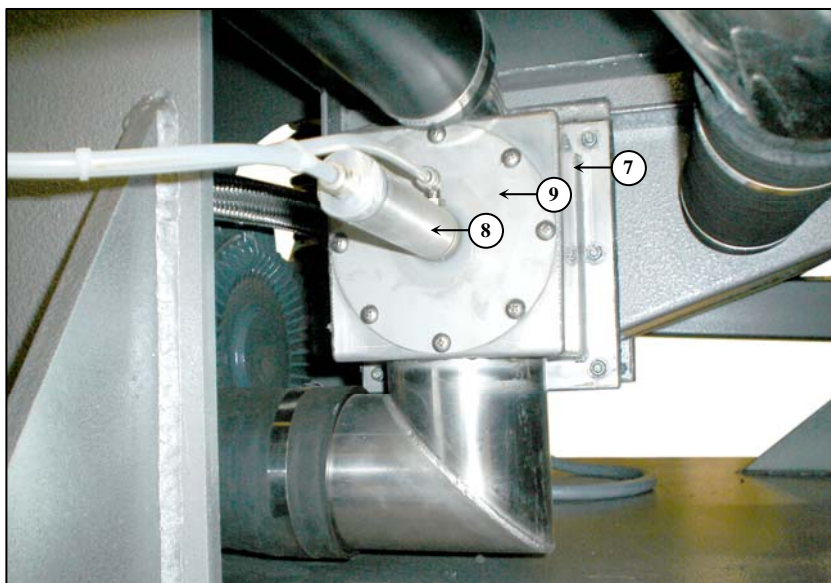
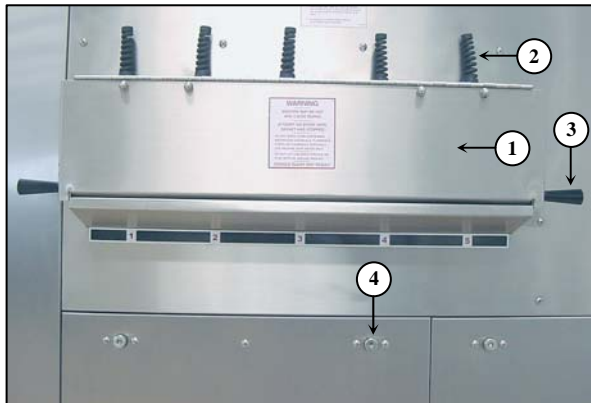

Item	Part No.					Qty.	Description
	110 lb.	135 lb.	200 lb.	275 lb.	300 lb.		
1	A1-S110-038	A1-S135-038	A1-S200-038	A1-S275-038	A1-S300-038	1	Supply dispenser cover
2	A0-A095-001	A0-A095-001	A0-A095-001	A0-A095-001	A0-A095-001	5	Strain relief for liquid chemical supply lines
3	A0-A086-002	A0-A086-002	A0-A086-002	A0-A086-002	A0-A086-002	2	Knobs BTH10 For supply dispenser
4	A0-A013-004	A0-A013-004	A0-A013-004	A0-A013-004	A0-A013-004	32	Latch, Adjustable grip
5	A0-A030-002	A0-A030-002	A0-A030-002	A0-A030-002	A0-A030-002	5	Plastic cups
6	A1-S110-011	A1-S135-011	A1-S200-011	A1-S275-011	A1-S300-011	1	Supply dispenser body
7	A1-SSII-044	A1-SSII-044	A1-SSII-044	A1-SSII-044	A1-SSII-044	1	Drain Box Shell
8	A0-P003-008	A0-P003-008	A0-P003-008	A0-P003-008	A0-P003-008	1	Air cylinder drain valve
9	A1-SSII-045	A1-SSII-045	A1-SSII-045	A1-SSII-045	A1-SSII-045	1	Drain Air Cylinder Mounting Plate
10	A1-SSII-048	A1-SSII-048	A1-SSII-048	A1-SSII-048	A1-SSII-048	1	Seal Backing Plate
11	A0-A001-019	A0-A001-019	A0-A001-019	A0-A001-019	A0-A001-019	1	Rubber seal for drain
12	A1-SSII-047	A1-SSII-047	A1-SSII-047	A1-SSII-047	A1-SSII-047	1	Seal Front Plate

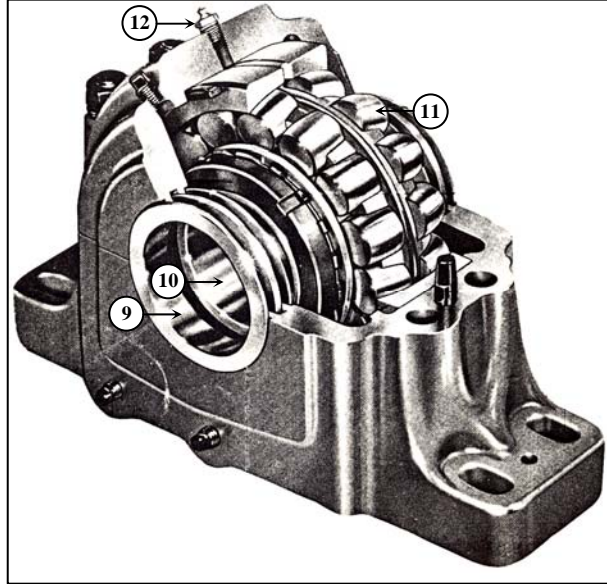
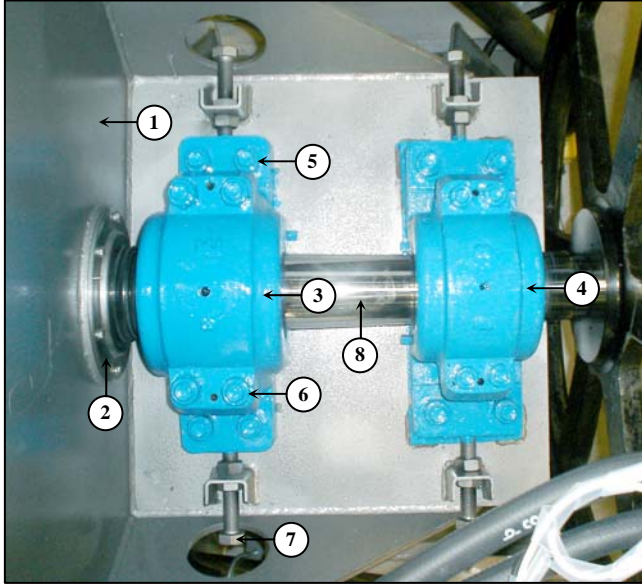

Item	Part No.					Qty.	Description
	110 lb.	135 lb.	200 lb.	275 lb.	300 lb.		
1	A1-S110-030	A1-S135-030	A1-S200-030	A1-S275-030	A1-S300-030	1	Assembly, Shell/Upper Frame
2	A1-SSI2-031	A1-S135-031	A1-S200-031	A1-SSI2-033	A1-SSI2-033	2	Seal plate, Formed
	A1-SSI2-032	A1-S135-032	A1-S200-032	A1-SSI2-034	A1-SSI2-034	1	Seal plate, Flat
3	A0-A005-001	A0-A005-002	A0-A005-004	A0-A005-005	A0-A005-005	6	Seal, V-Ring
	A0-A007-003	A0-A007-004	A0-A007-005	A0-A007-006	A0-A007-006	1	Housing, Front
4	A0-A007-002	A0-A007-003	A0-A007-004	A0-A007-005	A0-A007-006	1	Housing, Rear
5	A0-A077-013	A0-A074-401	A0-A077-027	A0-A077-026	A0-A077-026	2	Bolt for Lock Bearing Housing (Front)
	A0-A077-013	A0-A077-012	A0-A077-024	A0-TSJ01-251	A0-TSJ01-251	2	Bolt for Lock Bearing Housing (Rear)
6	A0-A077-010	A0-A077-016	A0-A074-406	A0-A077-025	A0-A077-025	2	Bolt for Housing (Front) Cover
	A0-A077-011	A0-A077-010	A0-A077-016	A0-A074-406	A0-A074-406	2	Bolt for Housing (Rear) Cover
7	A0-A079-012	A0-A079-012	A0-A079-005	A0-A079-005	A0-A079-005	4	Bolt for Bearing adjusting
8	A1-S110-029	A1-S135-029	A1-S200-029	A1-S275-029	A1-S300-029	1	Shaft, Basket stainless steel
9	A0-A005-019	A0-A005-021	A0-A005-022	A0-A005-024	A0-A005-024	2	Housing oil seal, (Front)
	A0-A005-026	A0-A005-019	A0-A005-021	A0-A005-022	A0-A005-022	2	Housing oil seal, (Rear)
10	A0-A006-008	A0-A006-012	A0-A006-009	A0-A006-010	A0-A006-010	1	Adapter-Sleeve, (Front)
	A0-A006-007	A0-A006-008	A0-A006-012	A0-A006-009	A0-A006-009	1	Adapter-Sleeve, (Rear)
11	A0-A004-003	A0-A004-004	A0-A004-005	A0-A004-006	A0-A004-006	1	Bearing, (Front)
	A0-A004-002	A0-A004-003	A0-A004-004	A0-A004-005	A0-A004-005	1	Bearing, (Rear)
12	A0-A024-001	A0-A024-001	A0-A024-001	A0-A024-001	A0-A024-001	2	Grease fitting 1/8"

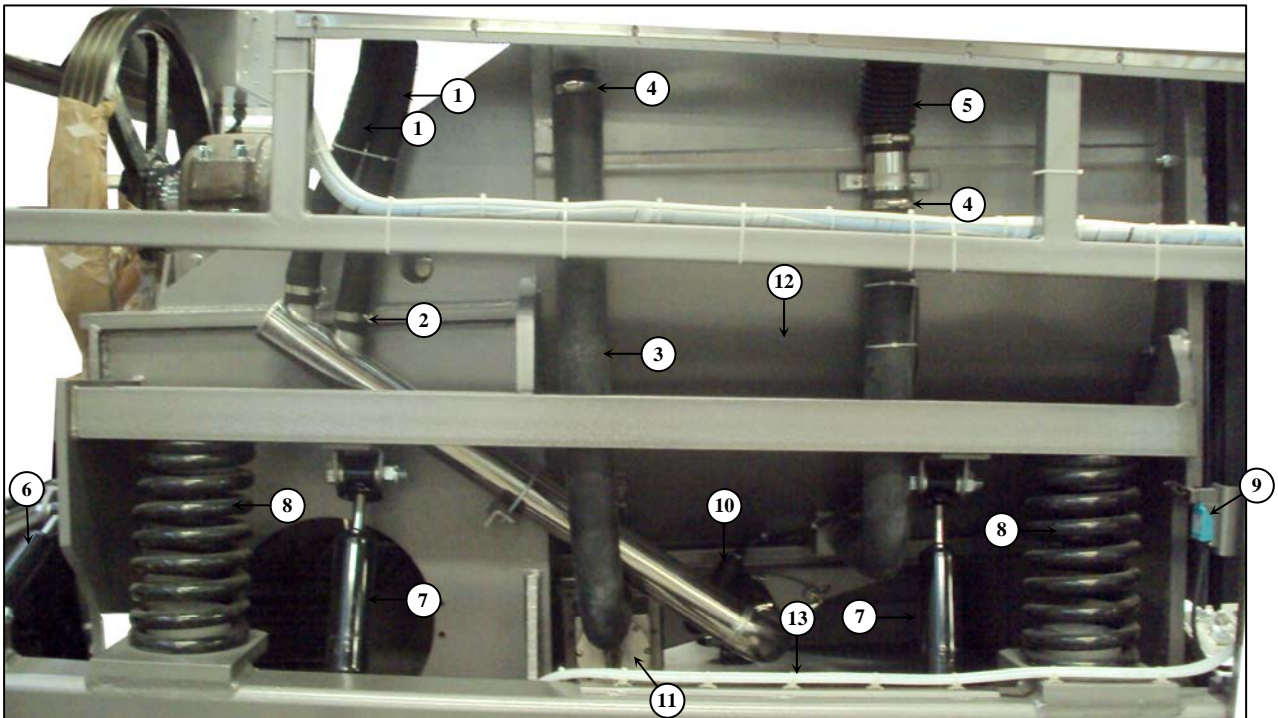

Item	Part No.					Qty.	Description
	110 lb.	135 lb.	200 lb.	275 lb.	300 lb.		
1	A0-A018-041	A0-A018-041	A0-A018-041	A0-A018-041	A0-A018-042	2	Water Inlet hose
2	A0-A052-004	A0-A052-004	A0-A052-004	A0-A052-004	A0-A052-004	4	Clamp hose
3	A0-A018-081	A0-A018-081	A0-A018-081	A0-A018-081	A0-A018-081	2	Overflow hose
4	A0-A052-004	A0-A052-004	A0-A052-004	A0-A052-004	A0-A052-004	-	Clamp hose
5	A0-A018-009	A0-A018-009	A0-A018-009	A0-A018-009	A0-A018-009	1	Rubber hose
6	A0-A031-120	A0-A031-120	A0-A031-120	A0-A031-120	A0-A031-120	4	Medium shock absorber
7	A0-A031-121	A0-A031-121	A0-A031-121	A0-A031-121	A0-A031-121	6	Shock absorber (Large)
8	A0-A008-012	A0-A008-013	A0-A008-001	A0-A008-014	A0-A008-014	4	Spring
9	A0-E011-018	A0-E011-018	A0-E011-018	A0-E011-018	A0-E011-018	2	Limit Switch
10	A0-A018-091	A0-A018-091	A0-A018-091	A0-A018-091	A0-A018-091	1	Hose, Water level
11	A1-SSII-044	A1-SSII-044	A1-SSII-044	A1-SSII-044	A1-SSII-044	1	Drain Box Shell
12	A0-E027-007	A0-E027-007	A0-E027-007	A0-E027-007	A0-E027-007	1	Temperature Probe
13	A0-P007-031	A0-P007-031	A0-P007-031	A0-P007-031	A0-P007-031	-	Air Hose 6 mm.
	A0-TSP01-335	A0-TSP01-335	A0-TSP01-335	A0-TSP01-335	A0-TSP01-335	-	Air Hose 8 mm.
	A0-TSP01-306	A0-TSP01-306	A0-TSP01-306	A0-TSP01-306	A0-TSP01-306	-	Air Hose 10 mm.

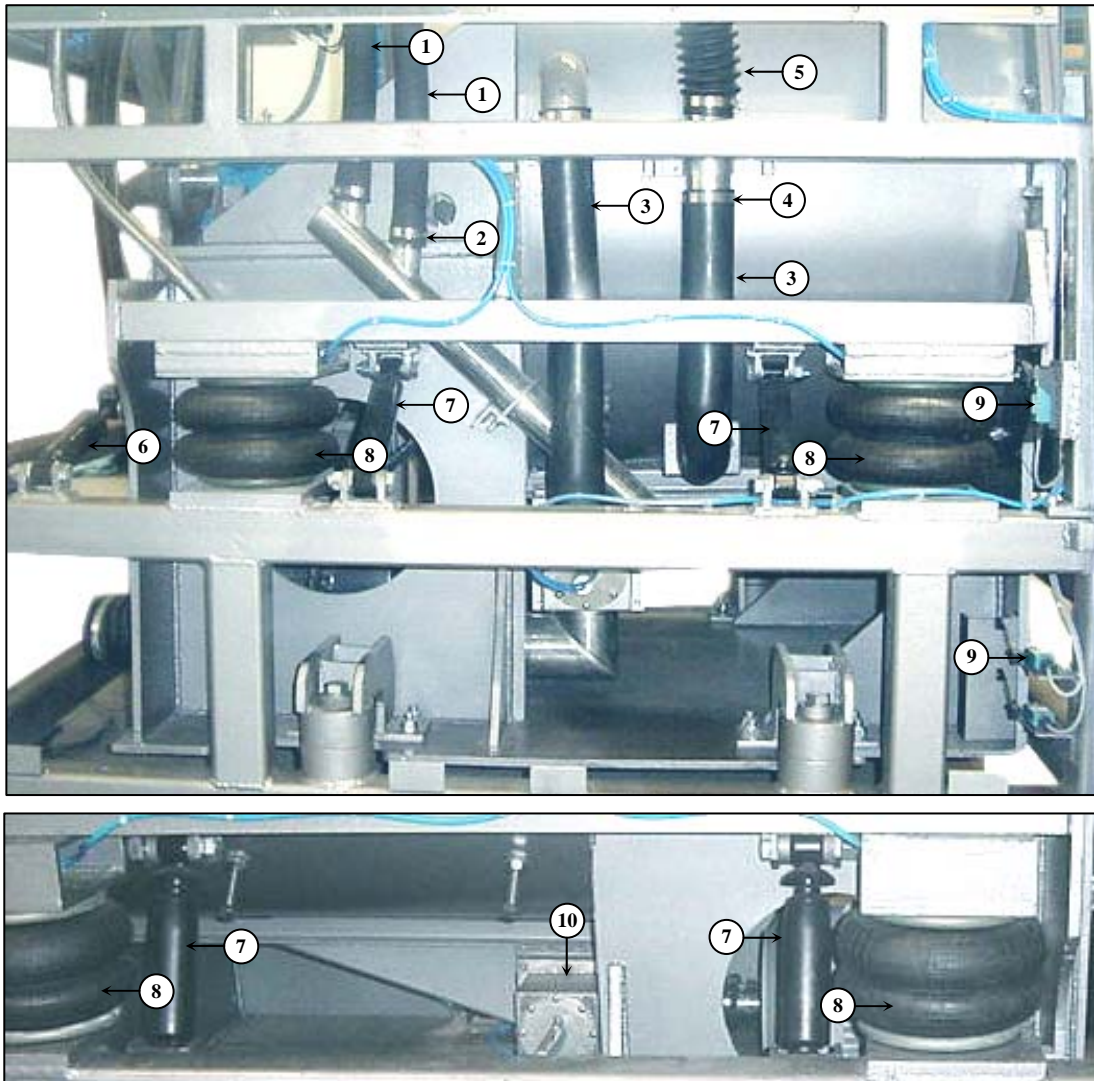

Item	Part No.					Qty.	Description
	110 lb.	135 lb.	200 lb.	275 lb.	300 lb.		
1	A0-A018-041	A0-A018-041	A0-A018-041	A0-A018-041	A0-A018-042	2	Water Inlet hose
2	A0-A052-004	A0-A052-004	A0-A052-004	A0-A052-004	A0-A052-004	4	Clamp hose
3	A0-A018-081	A0-A018-081	A0-A018-081	A0-A018-081	A0-A018-081	2	Overflow hose
4	A0-A052-004	A0-A052-004	A0-A052-004	A0-A052-004	A0-A052-004	-	Clamp hose
5	A0-A018-009	A0-A018-009	A0-A018-009	A0-A018-009	A0-A018-009	1	Flexible Detergent Hose Rubber hose
6	A0-A031-120	A0-A031-120	A0-A031-120	A0-A031-120	A0-A031-120	4	Medium shock absorber
7	A0-A031-121	A0-A031-121	A0-A031-121	A0-A031-121	A0-A031-121	6	Shock absorber (Large)
8	A0-P002-002	A0-P002-003	A0-P002-003	A0-P002-003	A0-P002-003	4	Air cushion
9	A0-E011-018	A0-E011-018	A0-E011-018	A0-E011-018	A0-E011-018	2	Limit Switch
10	A1-SS11-044	A1-SS11-044	A1-SS11-044	A1-SS11-044	A1-SS11-044	1	Drain Box Shell

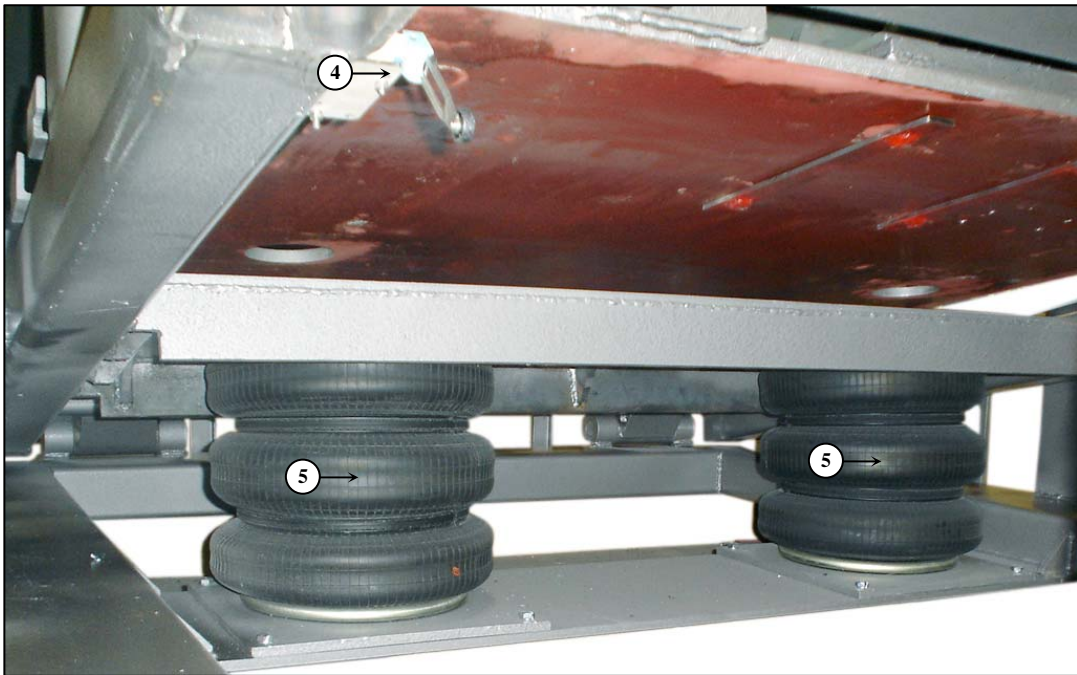
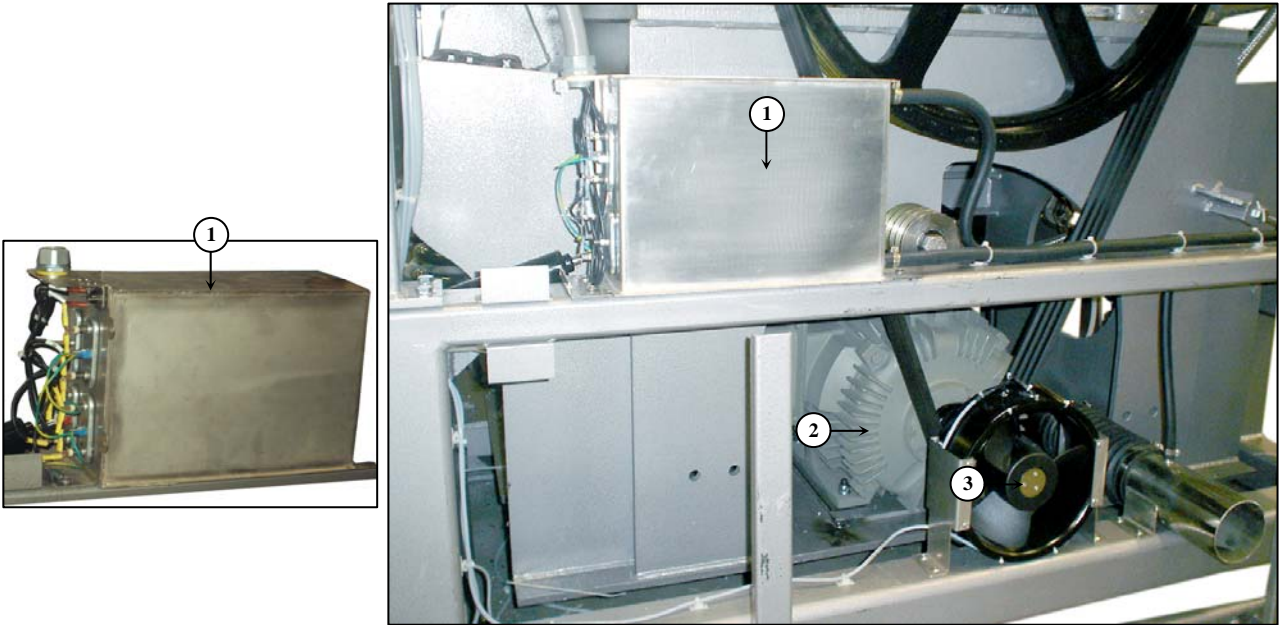

Item	Part No.					Qty.	Description
	110 lb.	135 lb.	200 lb.	275 lb.	300 lb.		
1	-	-	-	A0-E005-001	A0-E005-001	1	Heater Box 4000 w
	-	-	-	A0-E005-002	A0-E005-002	1	Heater Box 3000 w
2	A0-E008-220	A0-E008-219	A0-E008-218	A0-E008-216	A0-E008-216	1	Motor "Teco" (Std)
	-	A0-E008-854	A0-E008-218	A0-E008-217	A0-E008-217	1	Motor "Teco" (Option)
	A0-E008-003	A0-E008-004	A0-E008-005	A0-E008-006	A0-E008-006	1	Motor "US" (Option)
	A0-E008-120	A0-E008-121	A0-E008-122	A0-E008-123	A0-E008-123	1	Motor "Toshiba" (Option)
3	A0-E012-005	A0-E012-005	A0-E012-005	A0-E012-005	A0-E012-005	1	Cooling fan (110-120VAC, 50/60 Hz)
	A0-TSE01-1251	A0-TSE01-1251	A0-TSE01-1251	A0-TSE01-1251	A0-TSE01-1251	1	Cooling fan (220-230VAC, 50/60 Hz)
4	A0-E011-018	A0-E011-018	A0-E011-018	A0-E011-018	A0-E011-018	2	Limit Switch
5	A0-P002-003	A0-P002-004	A0-P002-004	A0-P002-004	A0-P002-004	2	Air Cushion (For 1 Direction Tilt)
	A0-P002-003	A0-P002-004	A0-P002-004	A0-P002-004	A0-P002-004	4	Air Cushion (For 2 Direction Tilt)

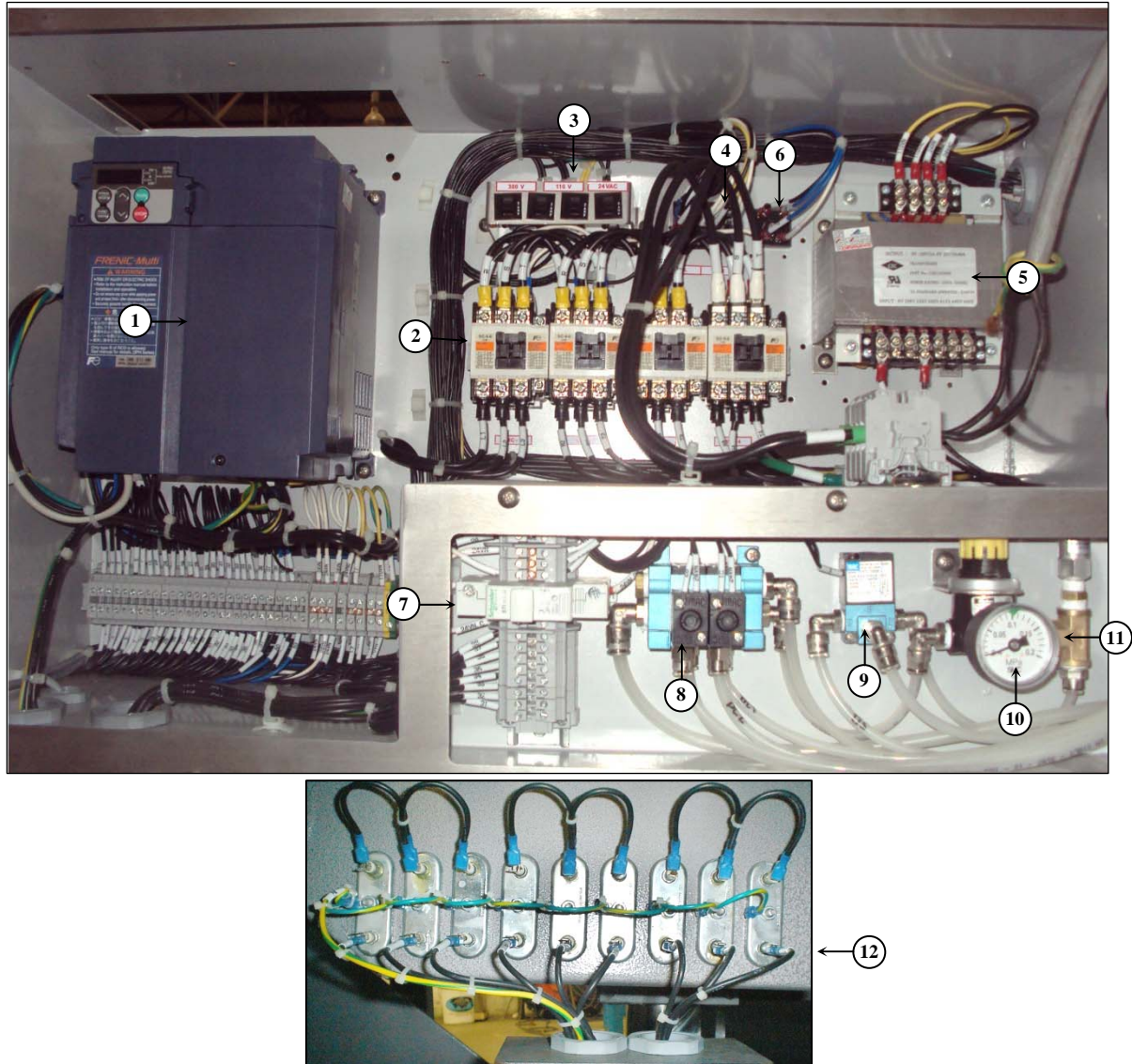

Item	Part No.	Qty.	Description
1	A0-E001-908	1	Inverter 7.5HP, 430V. 4BM1
	A0-E001-137	1	Inverter 7.5HP, 230V. 3PH.
	A0-E001-147	1	Inverter 7.5HP, 430V. 3PH.
2	A0-E004-070	4	Magnetic Contactor (SC-4-1 Coil 24VAC.)
	A0-E004-069	4	Magnetic Contactor (SC-4-0 Coil 24VAC.)
3	A0-E010-034	2	Breaker Fuse 3A.
	A0-E010-035	1	Breaker Fuse 2A.
	A0-E010-029	1	Breaker Fuse 6A.
4	A0-E009-017	2	Relay Coil 24VAC.
5	A0-E006-032	1	Transformer
6	A0-E050-002	1	Bridge Rectifier
7	A0-E010-068	1	Breaker Fuse 2A
	A0-E051-008	1	Fuse 2A 10X38,32A
8	A1-S201-036	2	Air Solenoid Valve Assembly
9	A0-P005-007	1	Air solenoid Valve
10	A0-P004-007	1	Regulator, Air Releif Valve
11	A0-P006-005	1	Air, Brass Fitting 3 way
12	A0-E005-001	12	Electric heater

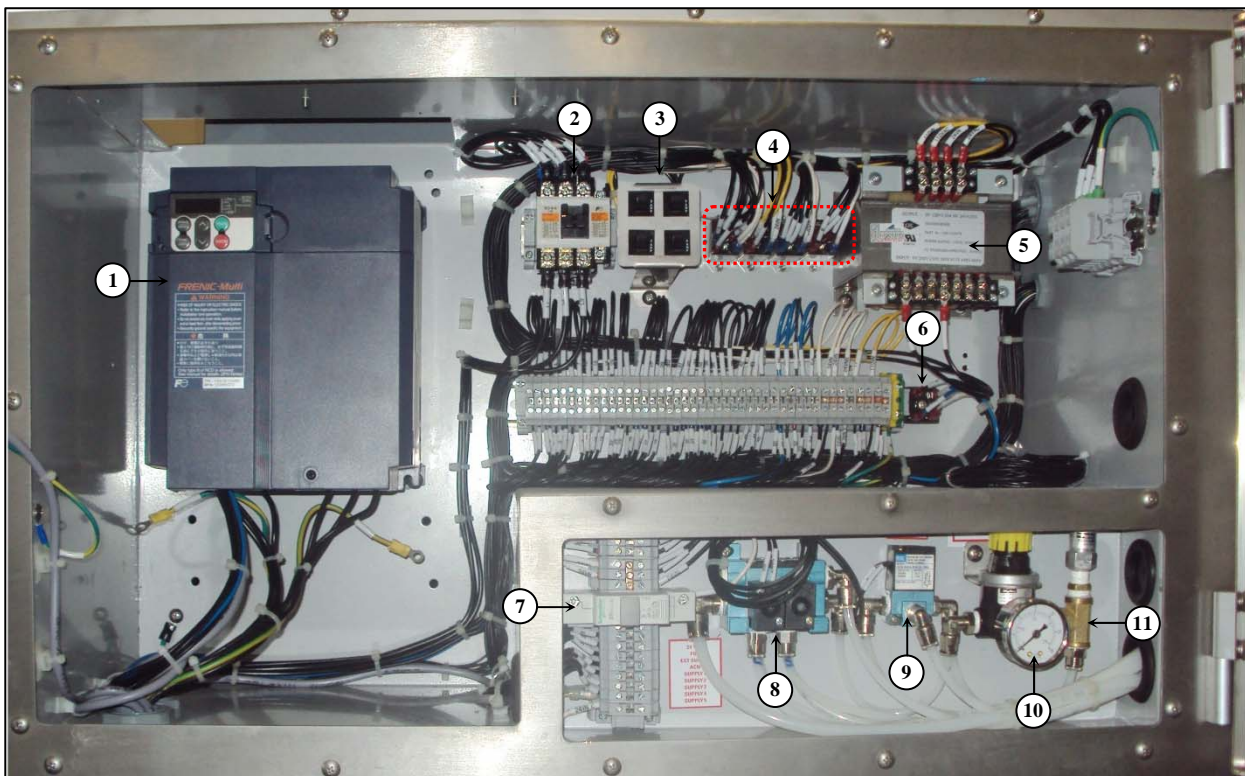

Item	Part No.	Qty.	Description
1	A0-E001-908	1	Inverter 7.5HP, 430V. 4BM1
	A0-E001-137	1	Inverter 7.5HP, 230V. 3PH.
	A0-E001-147	1	Inverter 7.5HP, 430V. 3PH.
2	A0-E004-069	1	Magnetic Contactor (SC-4-0 Coil 24VAC.)
3	A0-E010-034	2	Breaker Fuse 3A.
	A0-E010-035	1	Breaker Fuse 2A.
	A0-E010-029	1	Breaker Fuse 6A.
4	A0-E009-017	4	Relay Coil 24VAC.
5	A0-E006-032	1	Transformer
6	A0-E050-002	1	Bridge Rectifier
7	A0-E010-068	1	Breaker Fuse 2A
	A0-E051-008	1	Fuse 2A 10X38,32A
8	A1-S201-036	2	Air Solenoid Valve Assembly
9	A0-P005-007	1	Air solenoid Valve
10	A0-P004-007	1	Regulator, Air Relief Valve
11	A0-P006-005	1	Air, Brass Fitting 3 way

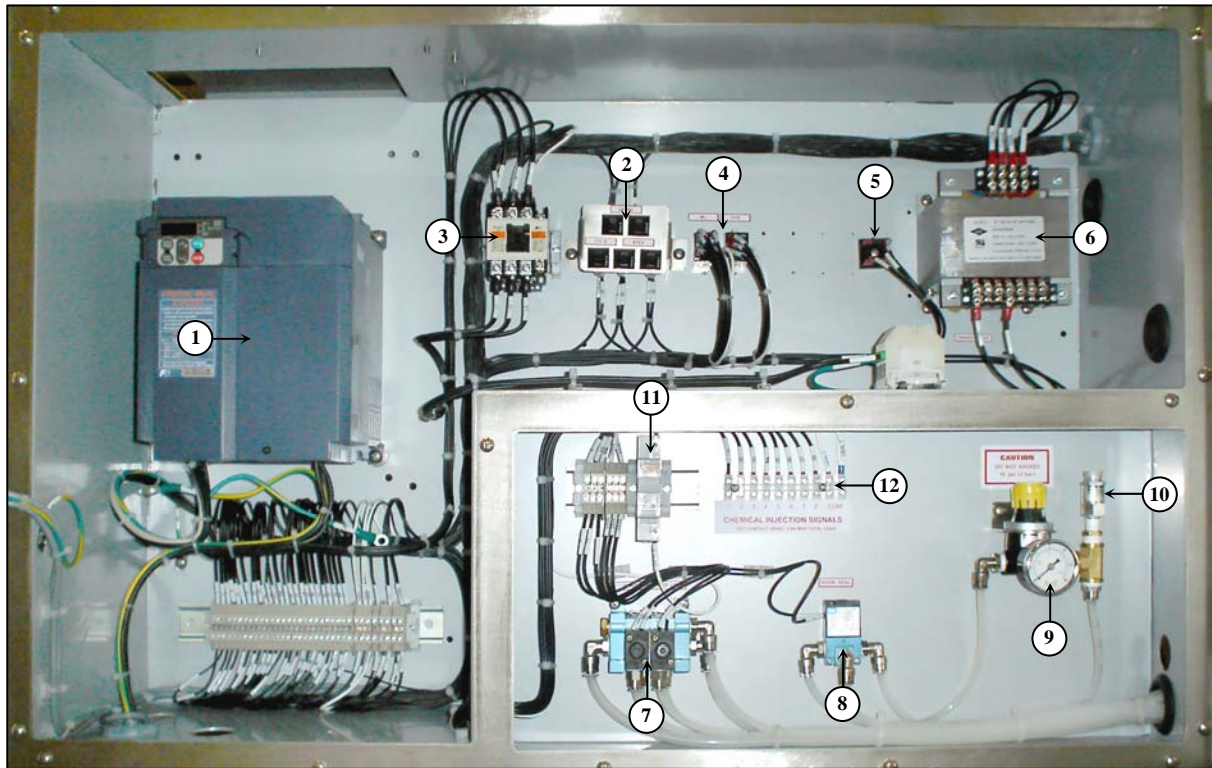

Item	Part No.	Qty.	Description
1	A0-E001-138	1	Inverter 10HP, 208-240V.
	A0-E001-148	1	Inverter 10HP, 430V.
2	A0-E010-034	2	Breaker Fuse 3A.
	A0-E010-035	1	Breaker Fuse 2A.
	A0-E010-029	2	Breaker Fuse 6A.
3	A0-E004-071	1	Magnetic Contactor (For main electric 208-240V)
	A0-E004-070	1	Magnetic Contactor (For main electric 380-415V)
4	A0-E009-017	2	Relay
5	A0-E050-002	1	Bridge Rectifier
6	A0-E006-032	1	Transformer
7	A1-S201-036	2	Air Solenoid Valve Assembly
8	A0-P005-007	1	Air solenoid Valve
9	A0-P004-007	1	Regulator, Air Relief Valve
10	A0-A046-003	1	Air, Brass Fitting 3 way
11	A0-E010-068	1	Breaker Fuse 2A
	A0-TSE01-1279	1	Fuse 1A 10X38 mm.
12	A0-E021-039	1	Block, Terminal

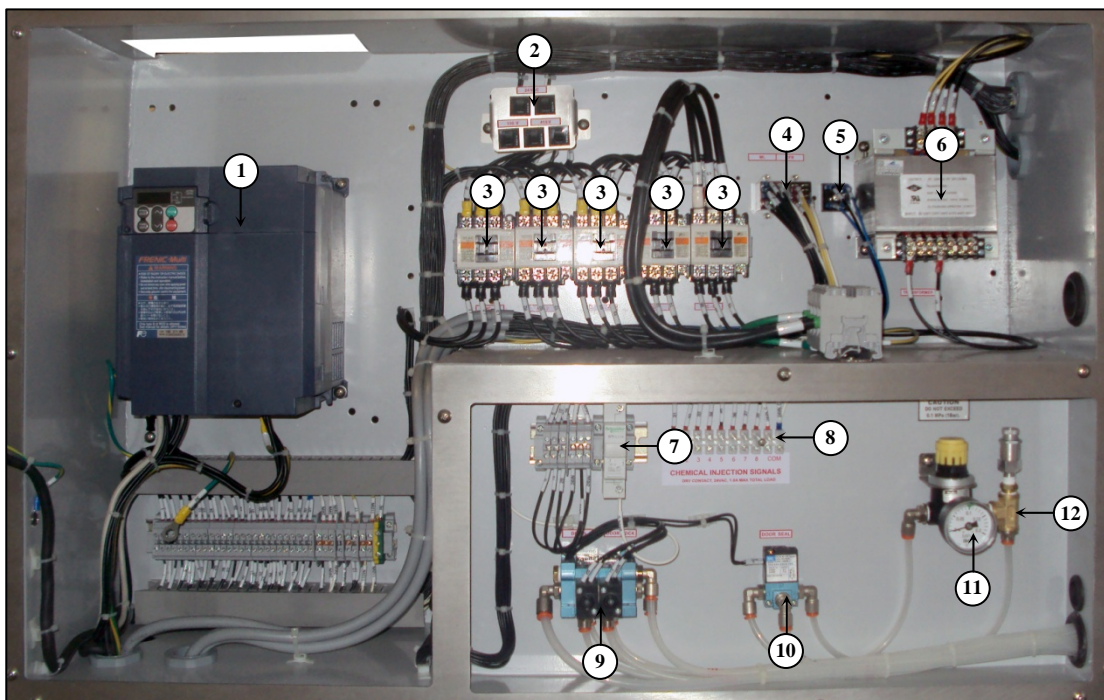

Item	Part No.	Qty.	Description
1	A0-E001-148	1	Inverter 10HP, 430V.3PH.
2	A0-E010-034	2	Breaker Fuse 3A.
	A0-E010-035	1	Breaker Fuse 2A.
	A0-E010-029	2	Breaker Fuse 6A.
3	A0-E004-070	5	Magnetic Contactor (SC-4-1 Coil 24VAC.)
4	A0-E009-017	2	Relay Coil 24VAC.
5	A0-E050-002	1	Bridge Rectifier
6	A0-E006-032	1	Transformer
7	A0-E010-068	1	Breaker fuse 2A
	A0-TSE01-1279	1	Fuse 1A 10X38 mm.
8	A0-E021-039	1	Block, Terminal
9	A1-S201-036	2	Air Solenoid Valve Assembly
10	A0-P005-007	1	Air solenoid Valve
11	A0-P004-007	1	Regulator, Air Releif Valve
12	A0-P006-005	1	Air, Brass Fitting 3 way
13	A0-E005-001	12	Electric heater

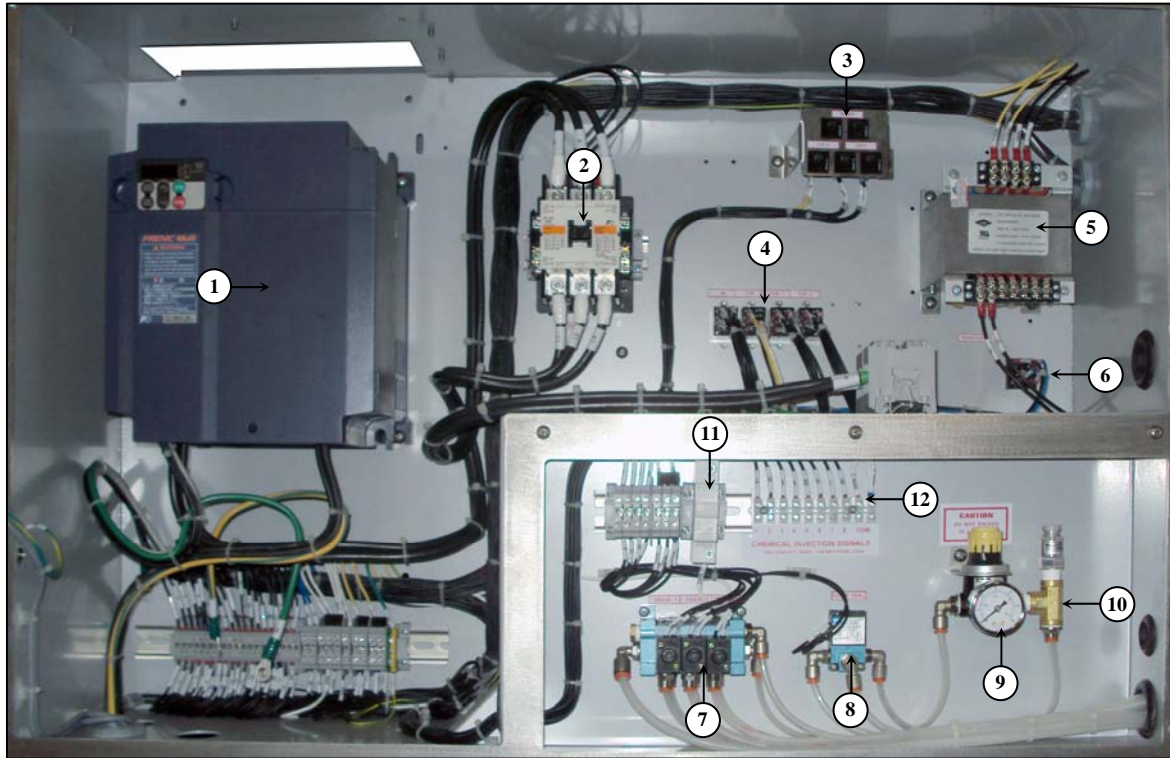

Item	Part No.	Qty.	Description
1	A0-E001-139	1	Inverter 230V.
	A0-E001-149	1	Inverter 460V.
2	A0-E004-076	1	Magnetic Contactor (For main electric 208-240V)
	A0-E004-072	1	Magnetic Contactor (For main electric 380-415V)
3	A0-E010-034	2	Breaker Fuse 3A.
	A0-E010-035	1	Breaker Fuse 2A.
	A0-E010-029	2	Breaker Fuse 6A.
4	A0-E009-017	1,4	Relay
5	A0-E006-032	1	Transformer
6	A0-E050-002	1	Bridge Rectifier
7	A1-S201-036	2-3	Air Solenoid Valve Assembly
8	A0-P005-007	1	Air Solenoid Valve
9	A0-P004-007	1	Regulator, Air Releif Valve
10	A0-A046-003	1	Air, Brass Fitting 3 way
11	A0-E010-068	1	Plugs Fuse
	A0-TSE01-1279	1	Fuse 1A 10X38 mm.
12	A0-E021-039	1	Block, Terminal

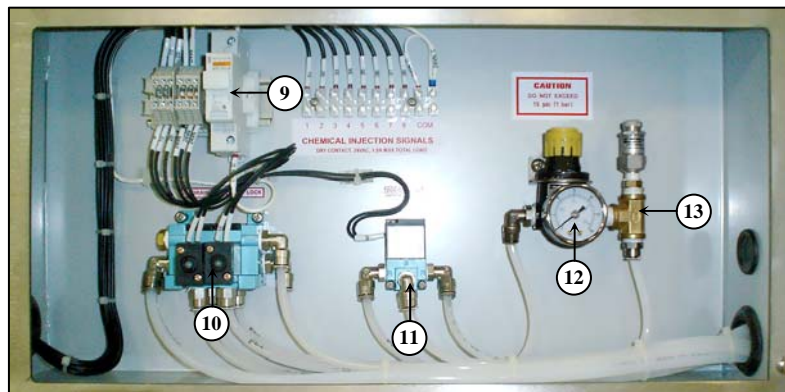
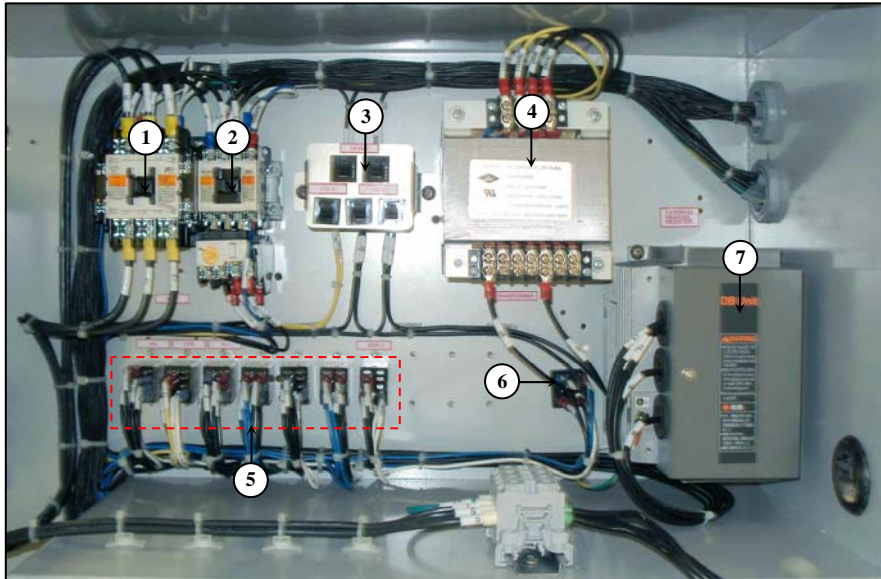

Item	Part No.	Qty.	Description
1	A0-E004-076	1	Magnetic Contactor (For main electric 208-240V)
	A0-E004-072	1	Magnetic Contactor (For main electric 380-415V)
2	A0-E004-065	1	Magnetic Contactor
	A0-E025-051	1	Overload
3	A0-E010-034	2	Breaker Fuse 3A.
	A0-E010-035	1	Breaker Fuse 2A.
	A0-E010-029	2	Breaker Fuse 6A.
4	A0-E006-032	1	Transformer
5	A0-E009-017	7	Relay
6	A0-E050-002	1	Bridge Rectifier
7	A0-E002-018	1	Brake unit 230V.
	A0-E002-020	1	Brake unit 460V.
8	A0-E001-139	1	Inverter 230V.
	A0-E001-149	1	Inverter 460V.
9	A0-E010-068	1	Plugs Fuse
	A0-TSE01-1279	1	Fuse 1A 10X38 mm.
10	A1-S201-036	2	Air Solenoid Valve Assembly
11	A0-P005-007	1	Air Solenoid Valve
12	A0-P004-007	1	Regulator, Air Releif Valve
13	A0-A046-003	1	Air, Brass Fitting 3 way

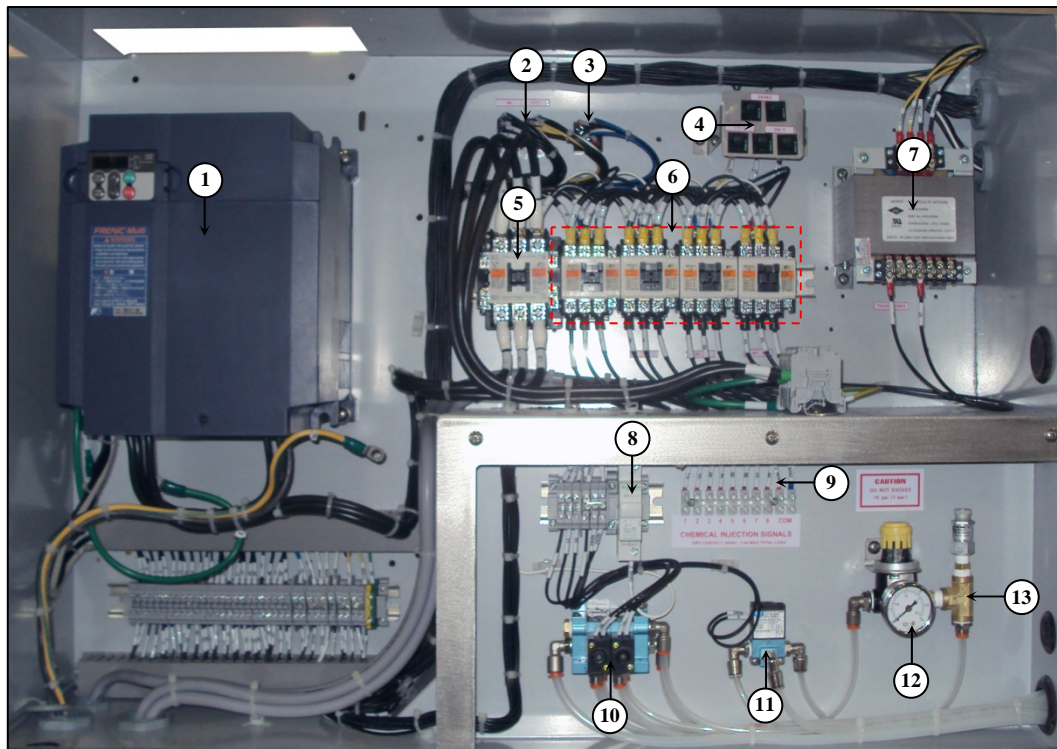

Item	Part No.	Qty.	Description
1	A0-E001-149	1	Inverter 20HP, 430V. 3PH.
2	A0-E009-017	2	Relay 24VAC
3	A0-E050-002	1	Bridge Rectifier
4	A0-E010-034	2	Breaker Fuse 3A.
	A0-E010-035	1	Breaker Fuse 2A.
	A0-E010-029	2	Breaker Fuse 6A.
5	A0-E004-072	1	Magnetic Contactor (SC-N2 Coil 24VAC.)
6	A0-E004-070	4	Magnetic Contactor (SC-4-1 Coil 24VAC.)
7	A0-E006-032	1	Transformer 50/60 HZ
8	A0-E010-068	1	Breaker fuse 2A
	A0-TSE01-1279	1	Fuse 1A 10X38 mm.
9	A0-E021-039	1	Block, Terminal
10	A1-S201-036	2	Air Solenoid Valve Assembly
11	A0-P005-007	1	Air solenoid Valve
12	A0-P004-007	1	Regulator, Air Relief Valve
13	A0-A046 -003	1	Air, Brass Fitting 3 way
14	A0-E005-001	12	Electric heater

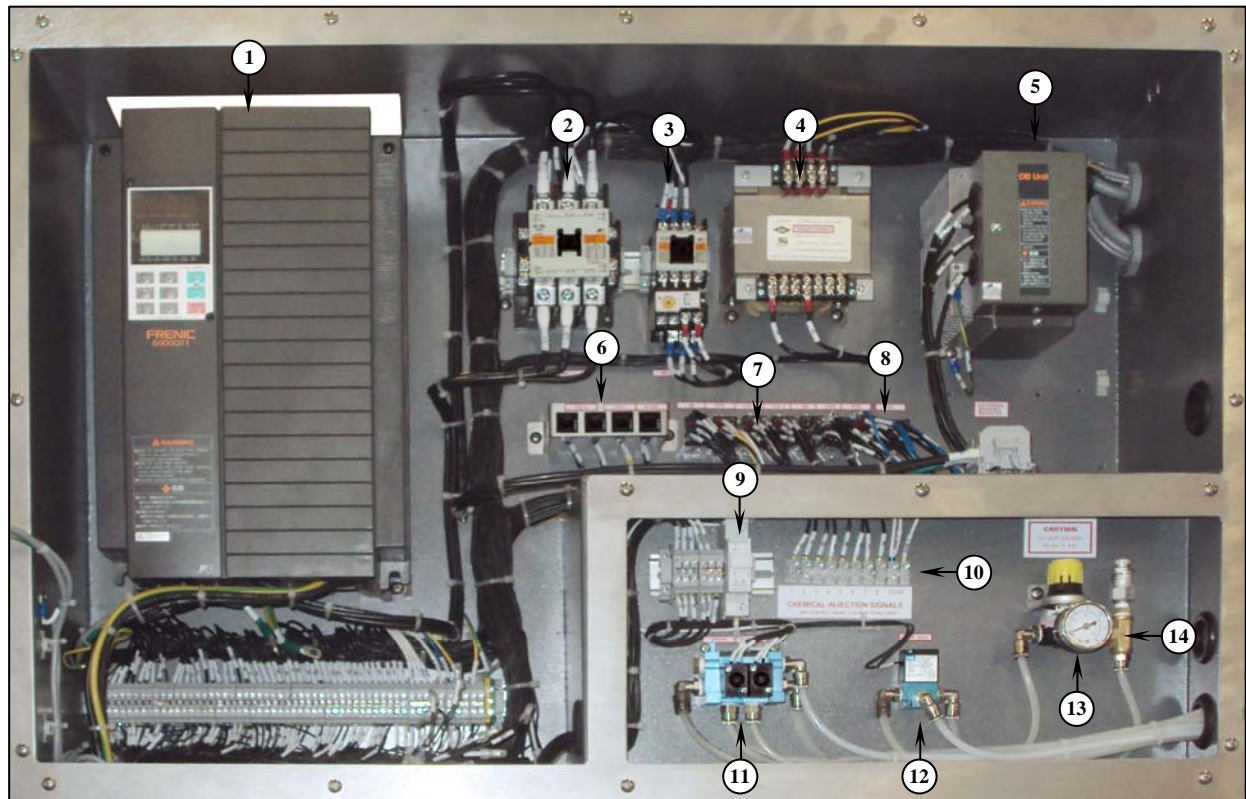

Item	Part No.	Qty.	Description
1	A0-E001-916	1	Inverter 30HP, 430V. 3PH.
2	A0-E004-076	1	Magnetic Contactor (SC-N3 Coil 24VAC.)
3	A0-E004-065	1	Magnetic Contactor (SC-03 Coil 24VAC.)
	A0-E025-051	1	Overload
4	A0-E006-032	1	Transformer
5	A0-E002-020	1	Brake Unit 25HP,30HP
6	A0-E010-034	2	Breaker Fuse 3A.
	A0-E010-035	1	Breaker Fuse 2A.
	A0-E010-029	2	Breaker Fuse 6A.
7	A0-E009-017	7	Relay 24VAC.
8	A0-E050-002	1	Bridge Rectifier
9	A0-E010-068	1	Breaker fuse 2A
	A0-TSE01-1279	1	Fuse 1A 10X38 mm.
10	A0-E021-039	1	Block, Terminal
11	A1-S201-036	2	Air Solenoid Valve Assembly
12	A0-P005-007	1	Air Solenoid Valve
13	A0-P004-007	1	Regulator, Air Releif Valve
14	A0-A046-003	1	Air, Brass Fitting 3 way

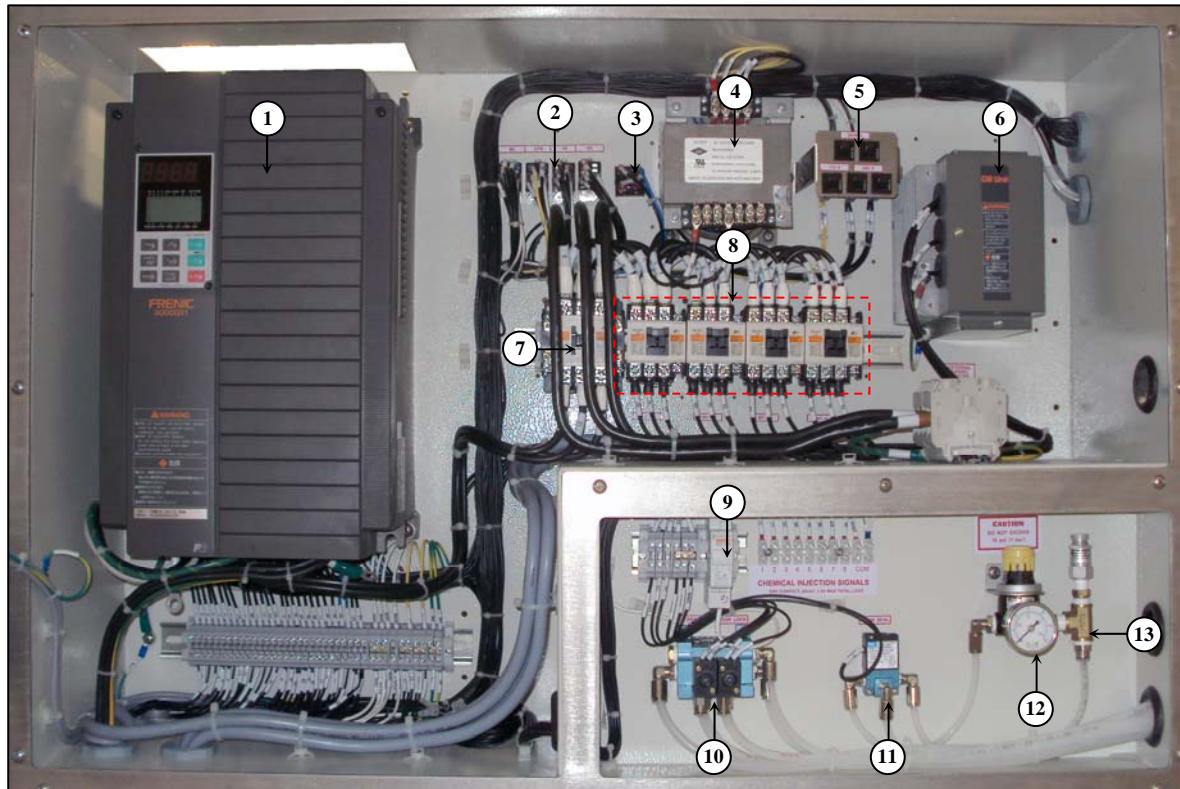

Item	Part No.	Qty.	Description
1	A0-E001-140	1	Inverter 230V.
	A0-E001-150	1	Inverter 460V.
2	A0-E009-017	4	Relay
3	A0-E050-002	1	Bridge Rectifier
4	A0-E006-032	1	Transformer
5	A0-E010-034	2	Breaker Fuse 3A.
	A0-E010-035	1	Breaker Fuse 2A.
	A0-E010-029	2	Breaker Fuse 6A.
6	A0-E002-018	1	Brake unit 230V.
	A0-E002-020	1	Brake unit 460V.
7	A0-E004-072	1	Magnetic Contactor
8	A0-E004-070	4	Magnetic Contactor
9	A0-E010-068	1	Plugs Fuse
	A0-TSE01-1279	1	Fuse 1A 10X38 mm.
10	A1-S201-036	2	Air Solenoid Valve Assembly
11	A0-P005-007	1	Air Solenoid Valve
12	A0-P004-007	1	Regulator, Air Releif Valve
13	A0-A046-003	1	Air, Brass Fitting 3 way
14	A0-E005-001	12	Electric heater

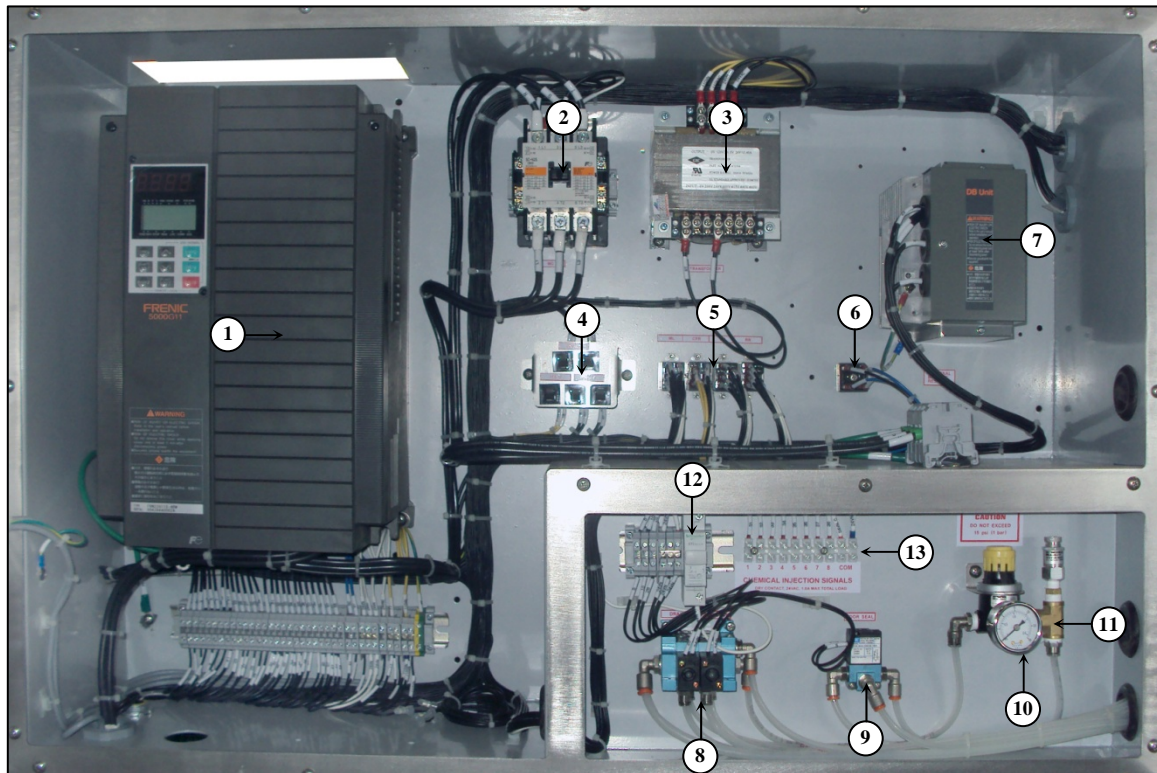

Item	Part No.	Qty.	Description
1	A0-E001-140	1	Inverter 25HP, 230V. 3PH.
	A0-E001-150	1	Inverter 25HP, 430V. 3PH.
2	A0-E004-073	1	Magnetic Contactor (SC-N2S Coil 24VAC.)
3	A0-E006-032	1	Transformer
4	A0-E010-034	2	Breaker Fuse 3A.
	A0-E010-035	1	Breaker Fuse 2A.
	A0-E010-029	2	Breaker Fuse 6A.
5	A0-E009-017	4	Relay 24VAC.
6	A0-E050-002	1	Bridge Rectifier
7	A0-E002-018	1	Brake unit 230V.
	A0-E002-020	1	Brake unit 460V.
8	A1-S201-036	2	Air Solenoid Valve Assembly
9	A0-P005-007	1	Air Solenoid Valve
10	A0-P004-007	1	Regulator, Air Releif Valve
11	A0-A046-003	1	Air, Brass Fitting 3 way
12	A0-E010-068	1	Breaker fuse 2A
	A0-TSE01-1279	1	Fuse 1A 10X38 mm.
13	A0-E021-039	1	Block, Terminal

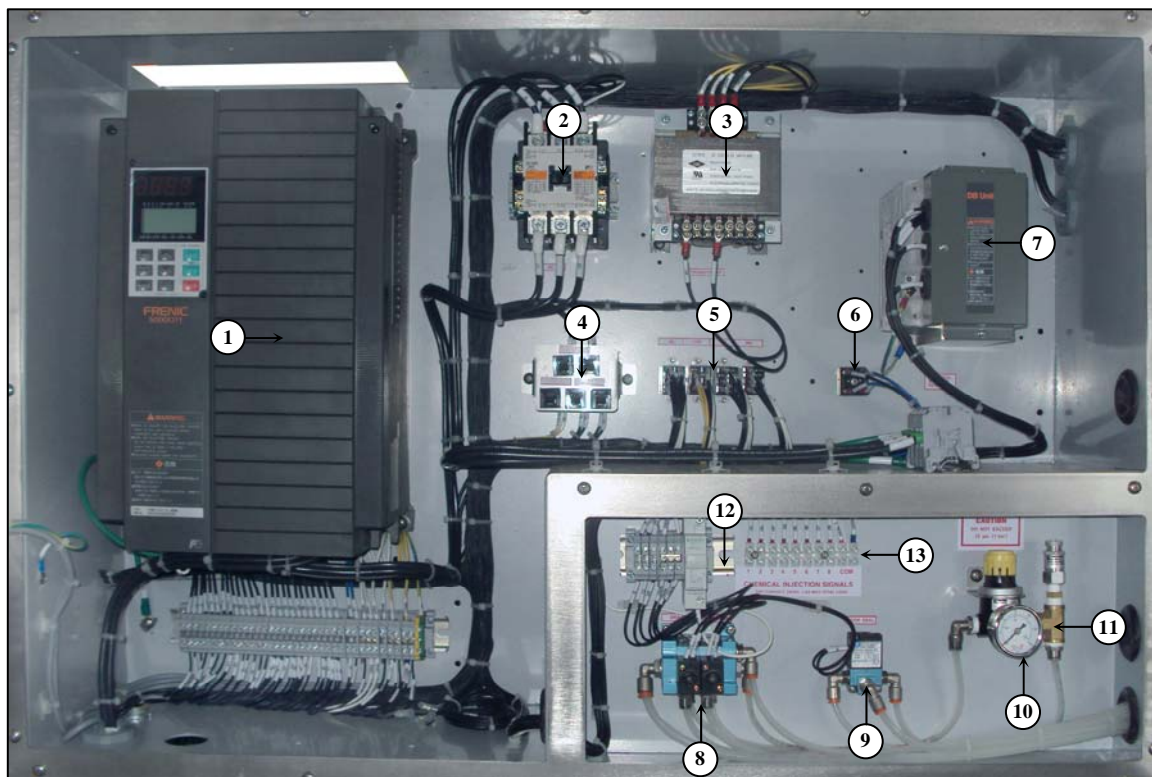

Item	Part No.	Qty.	Description
1	A0-E001-140	1	Inverter 230V.
	A0-E001-150	1	Inverter 460V.
2	A0-E004-073	1	Magnetic Contactor Coil 24VAC.
3	A0-E006-032	1	Transformer
4	A0-E010-034	2	Breaker Fuse 3A.
	A0-E010-035	1	Breaker Fuse 2A.
	A0-E010-029	2	Breaker Fuse 6A.
5	A0-E009-017	4	Relay
6	A0-E050-002	1	Bridge Rectifier
7	A0-E002-018	1	Brake unit 230V.
	A0-E002-020	1	Brake unit 460V.
8	A1-S201-036	2	Air Solenoid Valve Assembly
9	A0-P005-007	1	Air Solenoid Valve
10	A0-P004-007	1	Regulator, Air Relief Valve
11	A0-A046-003	1	Air, Brass Fitting 3 way
12	A0-E010-068	1	Breaker Fuse 2A
	A0-TSE01-1279	1	Fuse 1A 10X38 mm.
13	A0-E021-039	1	Block, Terminal

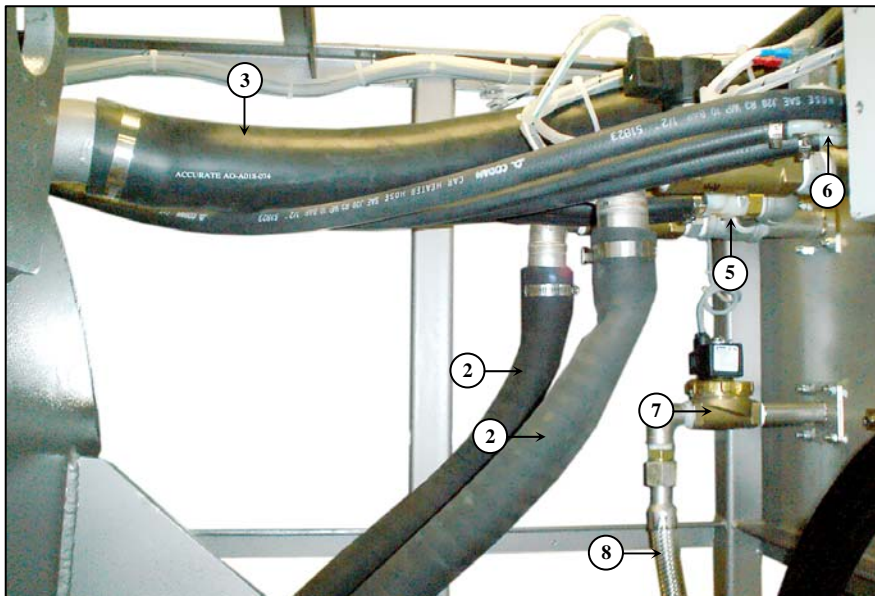
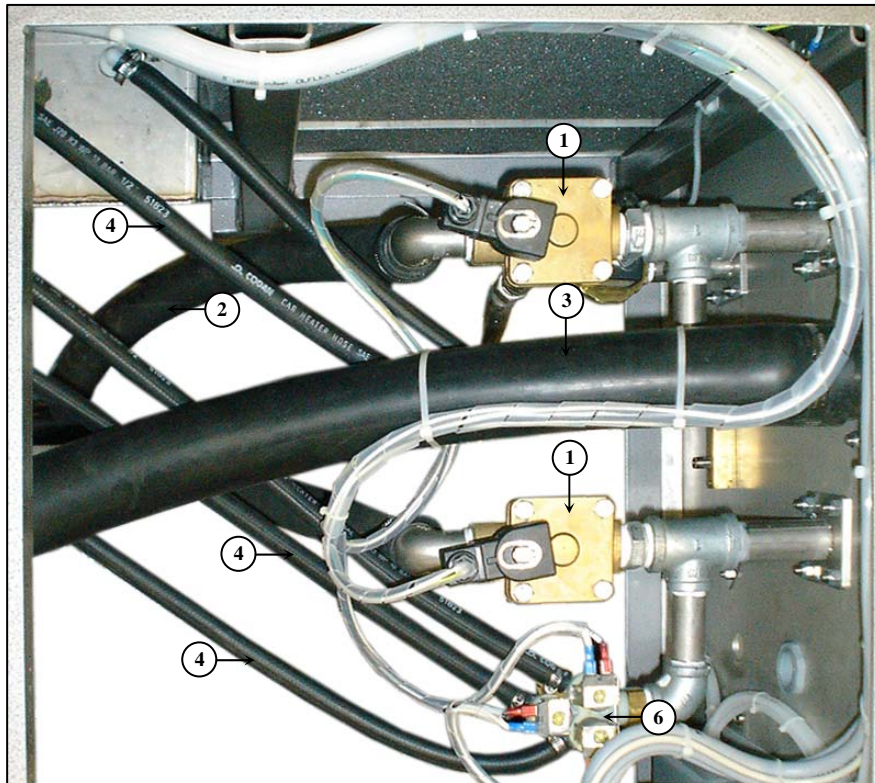

Item	Part No.	Qty.	Description
1	A0-E040-008	2	Valve, Water supply
2	A0-A018-041	2	Water inlet hose
3	A0-A018-081	1	Over flow hose
4	A0-A018-016	5	Hose, Supply chemical
5	A0-E040-001	1	Supply valve 2 way 3/4"
6	A0-E040-002	1	Valve, Supply chemical 3 way 3/4"
7	A0-E047-004	1	Valve, Steam
8	A0-A017-001	1	Flexible steam pipe

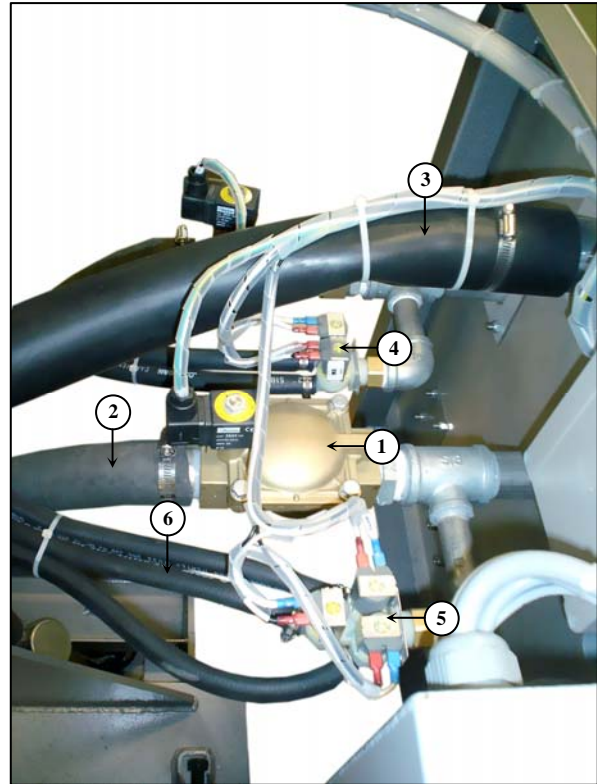
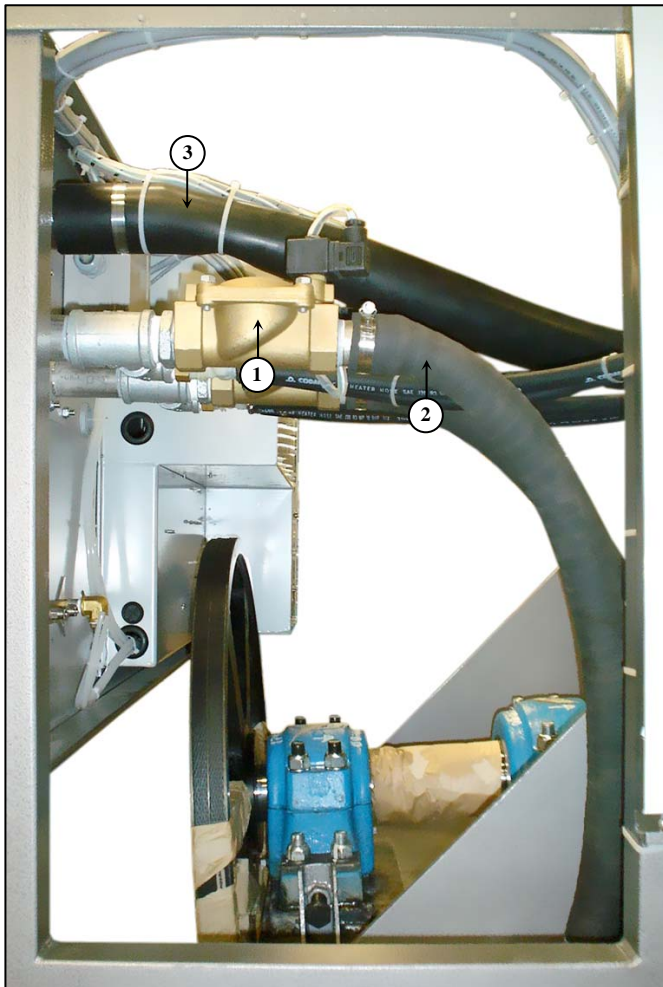

Item	Part No.	Qty.	Description
1	A0-E040-013	2	Solenoid water valve 1-1/4"-1-1/8"
2	A0-A018-041	2	Water inlet hose
3	A0-A018-081	1	Over flow hose
4	A0-E040-001	1	Supply valve 2 way 3/4"
5	A0-E040-002	1	Valve, Supply chemical 3 way 3/4"
6	A0-A018-016	5	Hose, Supply chemical

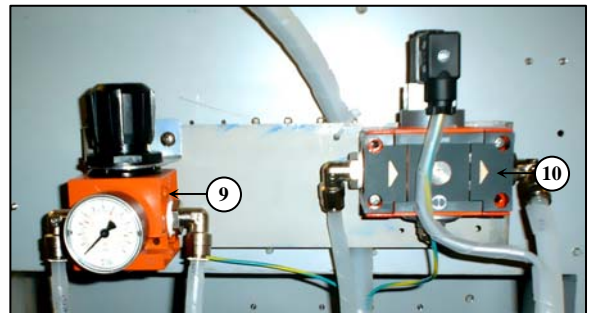
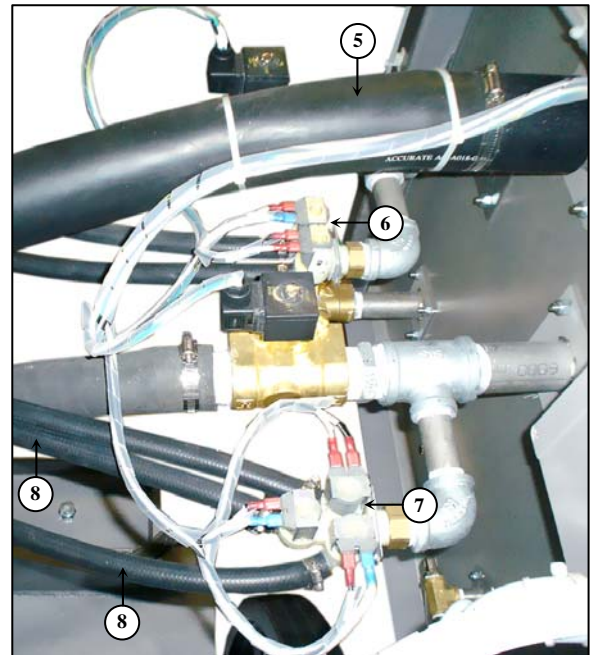
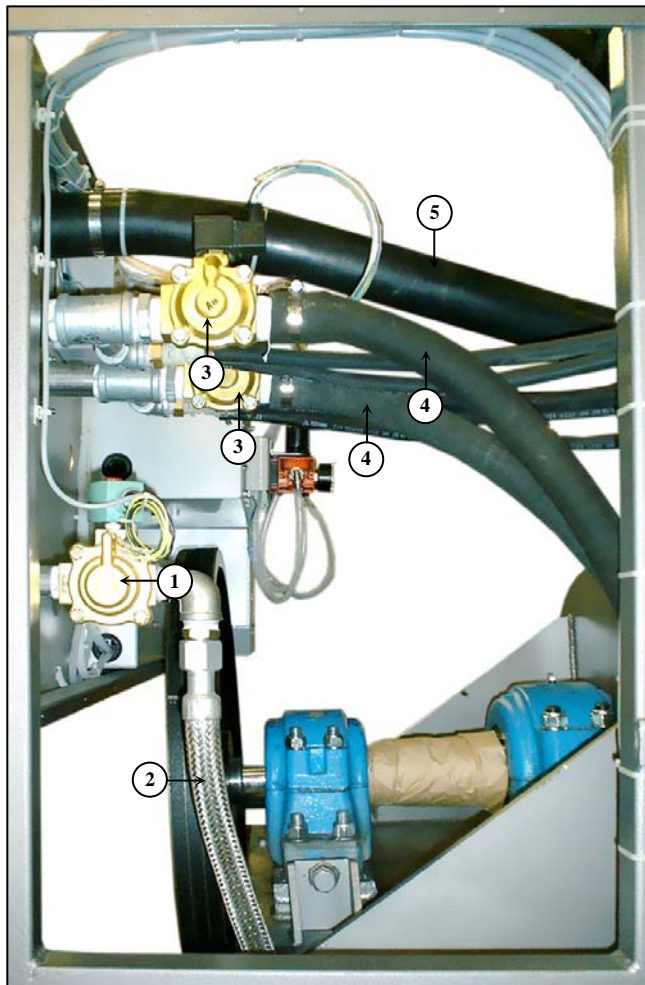

Item	Part No.	Qty.	Description
1	A0-E047-074	1	Valve, Steam
2	A0-A017-013	1	Flexible steam pipe
3	A0-E040-013	2	Solenoid water valve 1-1/4"-1-1/8"
4	A0-A018-041	2	Water inlet hose
5	A0-A018-081	1	Over flow hose
6	A0-E040-001	1	Supply valve 2 way 3/4"
7	A0-E040-002	1	Valve, Supply chemical 3 way 3/4"
8	A0-A018-016	5	Hose, Supply chemical
9	A0-P004-023	1	Regulator
10	A0-P005-171	1	Air Solenoid Valve

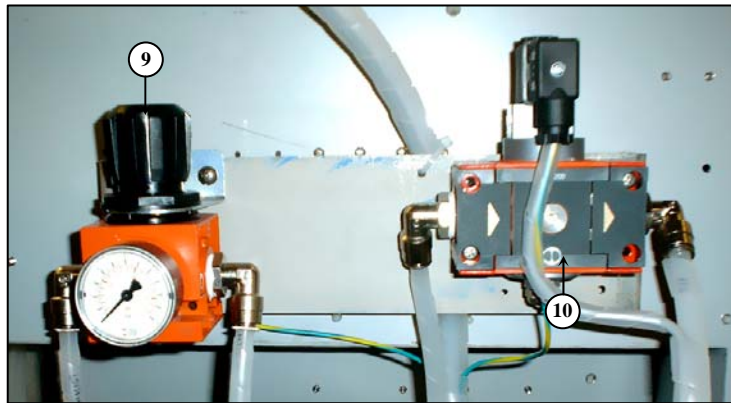
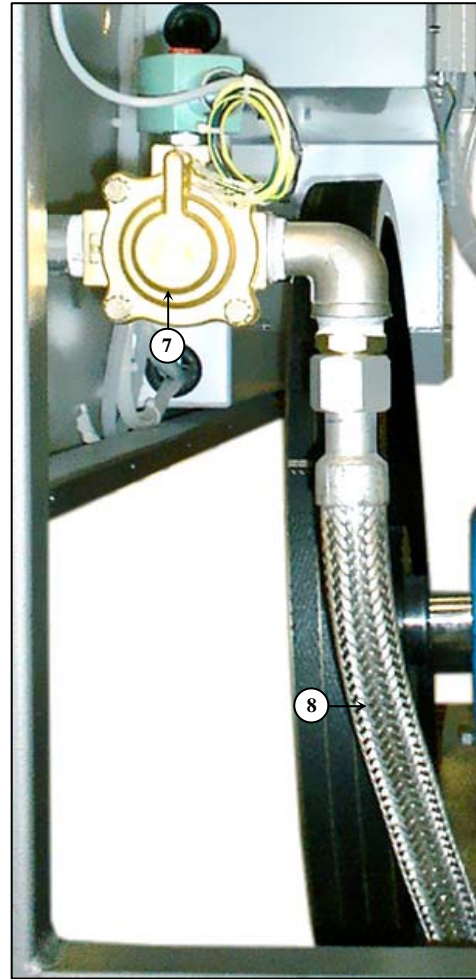
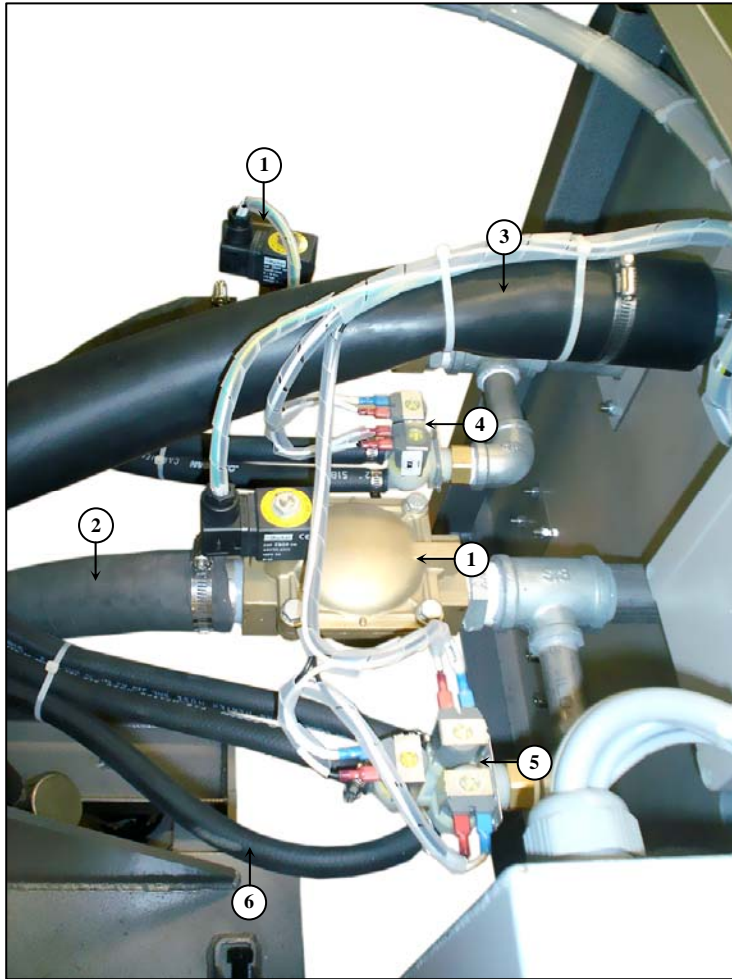

Item	Part No.	Qty.	Description
1	A0-E040-025	2	Valve, Water supply
2	A0-A018-041	2	Water inlet hose
3	A0-A018-081	1	Over flow hose
4	A0-E040-001	1	Supply valve 2 way 3/4"
5	A0-E040-002	1	Valve, Supply chemical 3 way 3/4"
6	A0-A018-016	5	Hose, Supply chemical
7	A0-E047-074	1	Valve, Steam
8	A0-A017-013	1	Flexible steam pipe
9	A0-P004-023	1	Regulator
10	A0-P005-171	1	Air Solenoid Valve

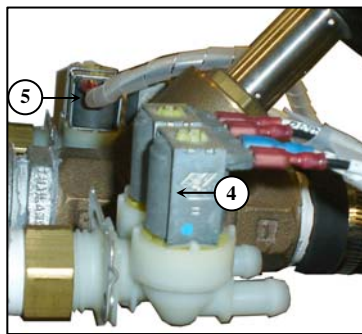
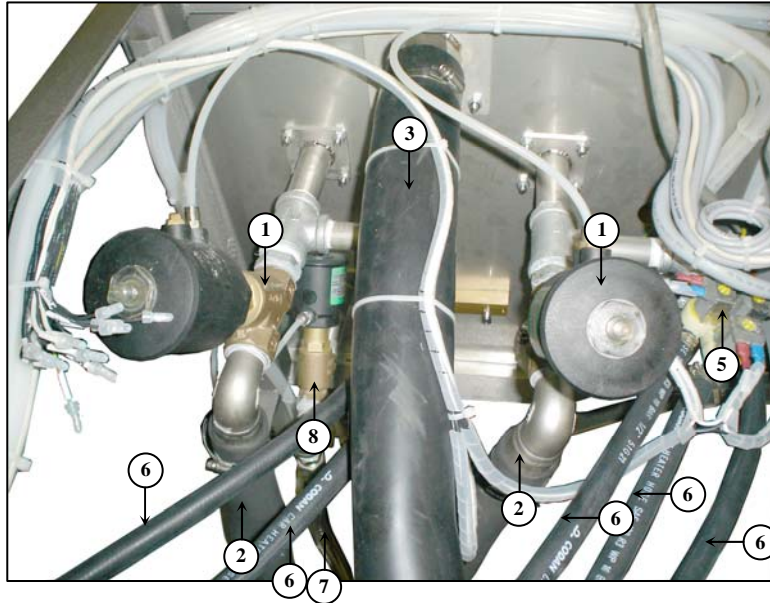

Item	Part No.	Qty.	Description
1	A0-E047-070	1	Piston Valve Size 1"
2	A0-A018-041	2	Water inlet hose
3	A0-A018-030	1	Dispenser hose ID 2 1/2"
4	A0-E040-001	2	Supply valve 2 way 3/4"
5	A0-E040-002	1	Valve, Supply chemical 3 way 3/4"
6	A0-A018-016	5	Hose, water supply size 1/2" (5 mm)
7	A0-A017-098	1	Flexible steam pipe 1"X1600mm
8	A0-P012-006	5	Piston valve size 1"

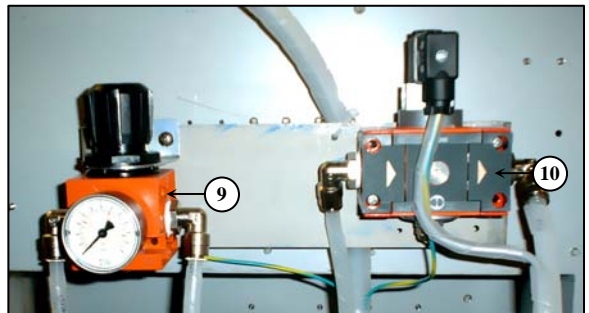
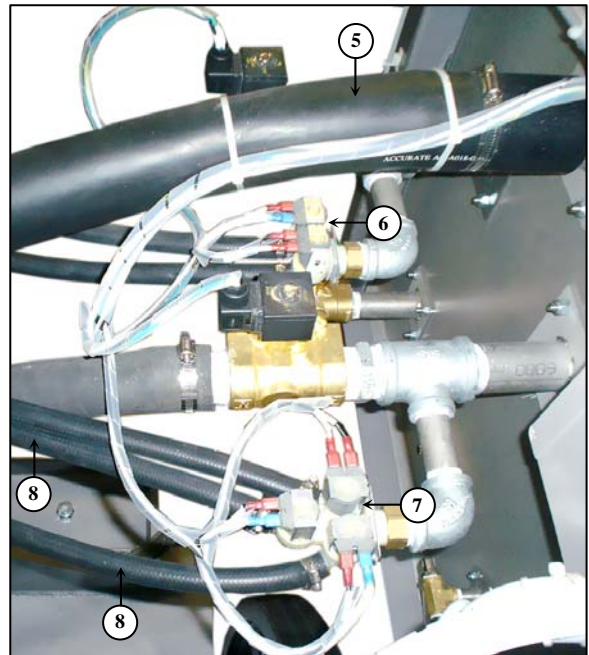
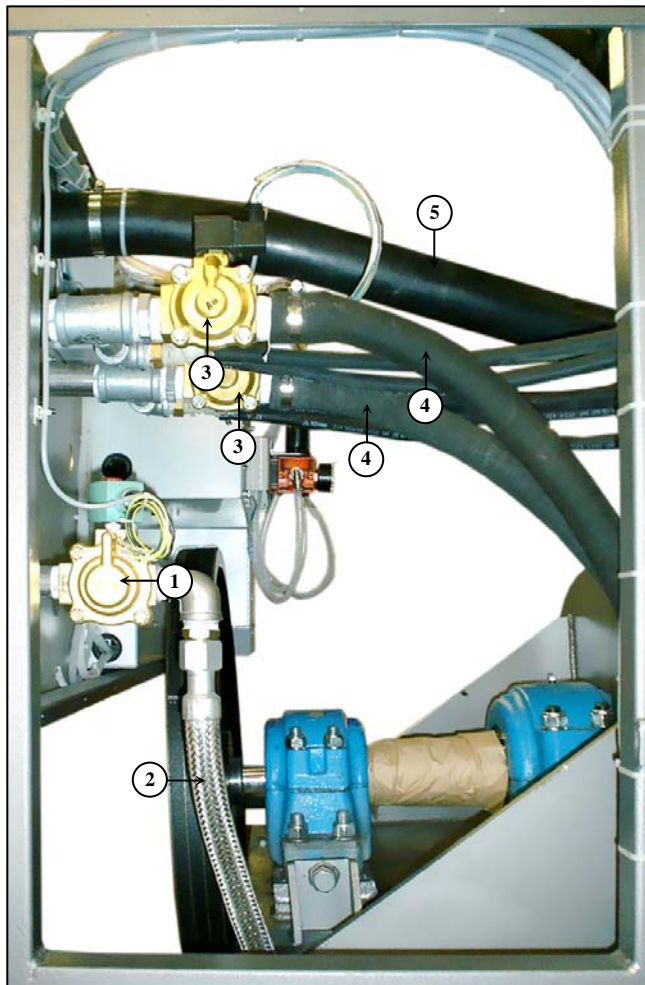

Item	Part No.	Qty.	Description
1	A0-E047-074	1	Valve, Steam
2	A0-A017-013	1	Flexible steam pipe
3	A0-E040-013	2	Solenoid water valve 1-1/4"-1-1/8"
4	A0-A018-041	2	Water inlet hose
5	A0-A018-081	1	Over flow hose
6	A0-E040-001	1	Supply valve 2 way 3/4"
7	A0-E040-002	1	Valve, Supply chemical 3 way 3/4"
8	A0-A018-016	5	Hose, Supply chemical
9	A0-P004-023	1	Regulator
10	A0-P005-171	1	Air Solenoid Valve

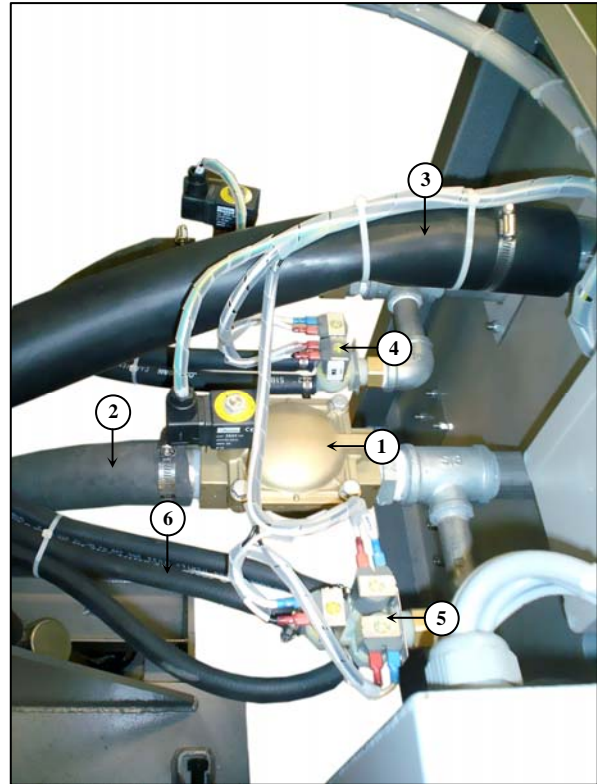
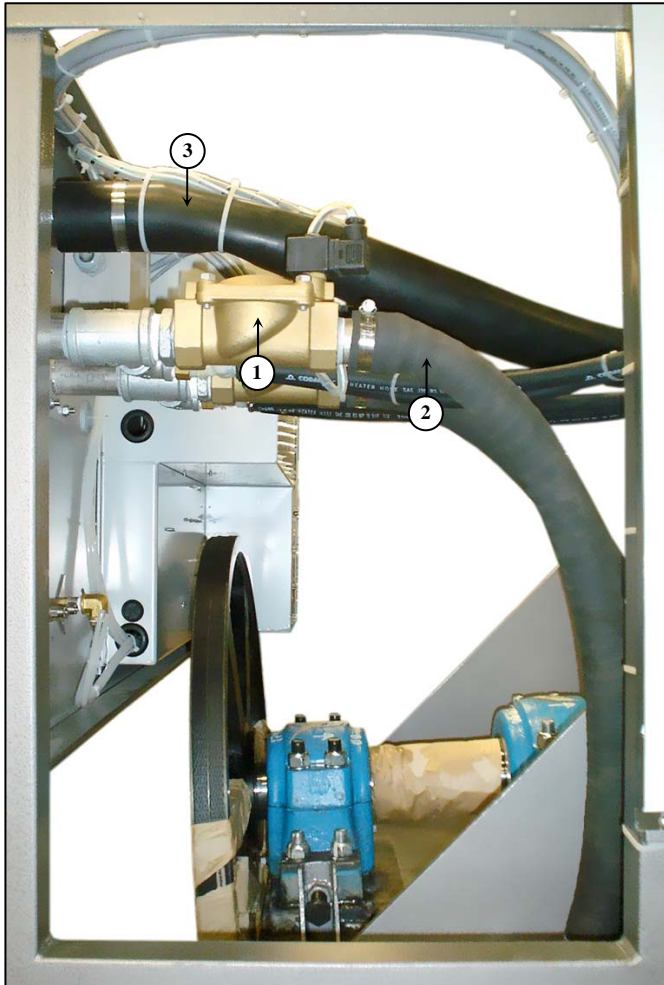

Item	Part No.	Qty.	Description
1	A0-E040-025	2	Valve, Water supply
2	A0-A018-041	2	Water inlet hose
3	A0-A018-081	1	Over flow hose
4	A0-E040-001	1	Supply valve 2 way 3/4"
5	A0-E040-002	1	Valve, Supply chemical 3 way 3/4"
6	A0-A018-016	5	Hose, Supply chemical

SMALL DOOR TYPE



LARGE DOOR TYPE

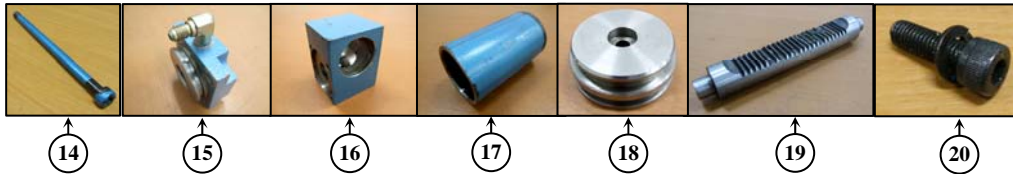
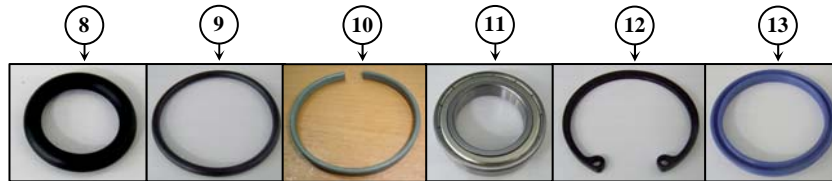
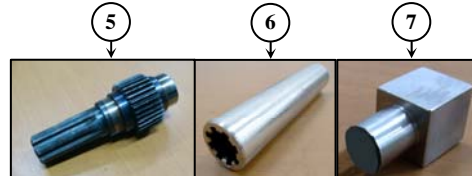
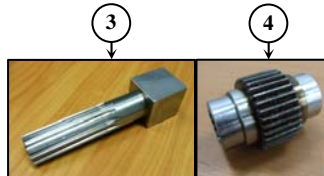

Item	Part No.	Qty.	Description
1	A0-P011-007	1	Ass'y, Hydraulic door cylinder, Female, Spline, 25
2	A0-P011-008	1	Ass'y, Hydraulic door cylinder, Male, Spline, 29
3	A1-SSI1-075	1	Spline, Male with mounting block
4	A1-SSI1-076	1	Gear, Pinion female spline
5	A1-SSI1-077	1	Gear, Pinion male spline
6	A1-SSI1-078	1	Spline, Female, Extension
7	A1-SSI1-105	1	Spline mounting block
8	A0-A005-171	2	Seal o-ring for rack
9	A0-A005-172	2	Seal o-ring for end block
10	A0-A005-174	2	Centering ring
11	A0-A004-197	2	Ball bearing for pinion
12	A0-A042-072	2	Cir clip, Internal
13	A0-A005-257	2	Seal, Hydraulic
14	A0-A070-054	8	Socket screw
15	A1-SSI1-070	2	Housing end
16	A1-SSI1-071	1	Housing block
17	A1-SSI1-072	2	Housing cylinder
18	A1-SSI1-103	2	Piston for cylinder
19	A1-SSI1-074	1	Rack for pinion
20	A0-A079-032	2	Socket screw
	A0-A082-002	2	Spring washer.

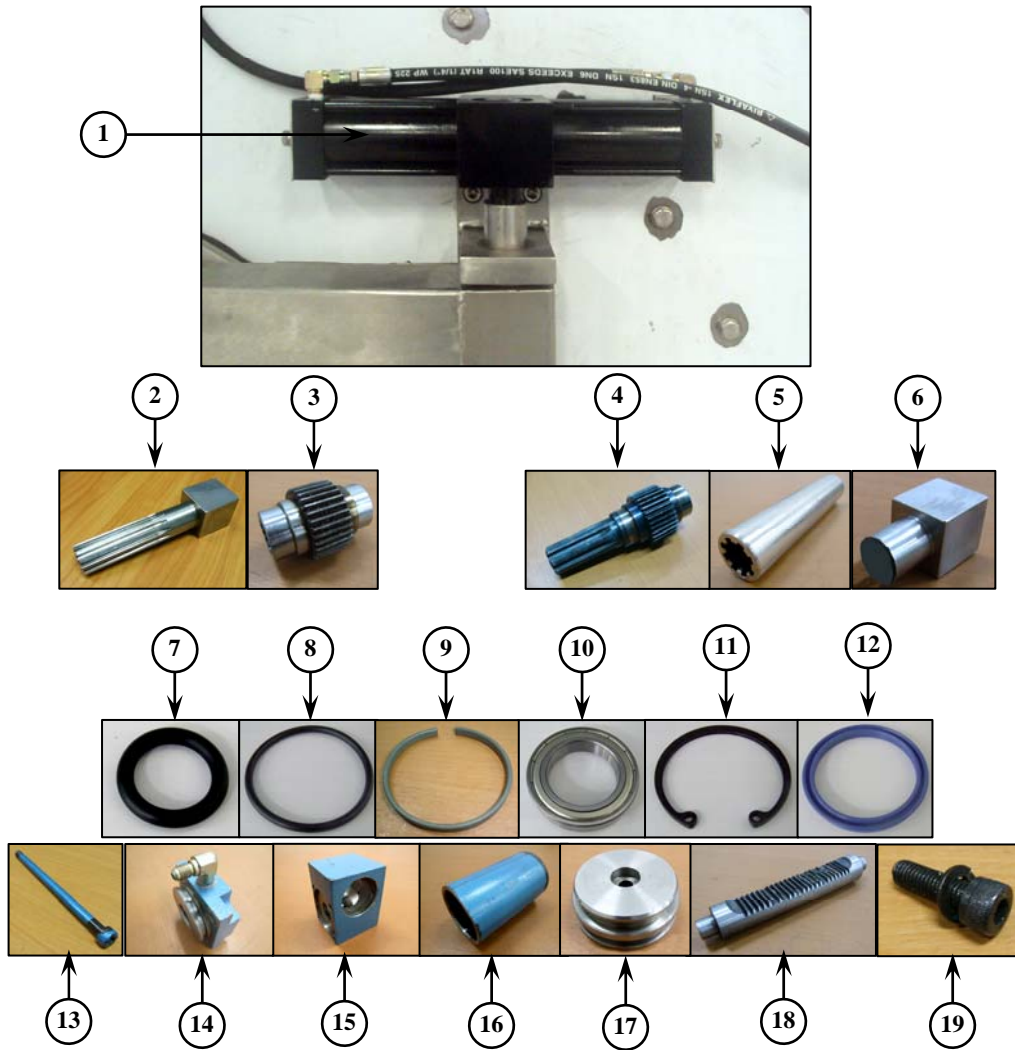

Item	Part No.	Qty.	Description
1	A0-P011-007	1	Hydraulic door cylinder bore 63x81 mm
2	A1-SSI1-075	1	Spline, Male with mounting block
3	A1-SSI1-076	1	Gear, Pinion female spline
4	A1-SSI1-077	1	Gear, Pinion male spline
5	A1-SSI1-078	1	Spline, Female, Extension
6	A1-SSI1-105	1	Spline mounting block
7	A0-A005-171	2	Seal o-ring for rack
8	A0-A005-172	2	Seal o-ring for end block
9	A0-A005-174	2	Centering ring
10	A0-A004-197	2	Ball bearing for pinion
11	A0-A042-072	2	Cir clip, Internal
12	A0-A005-257	2	Seal, Hydraulic
13	A0-A070-054	8	Socket screw
14	A1-SSI1-070	2	Housing end
15	A1-SSI1-071	1	Housing block
16	A1-SSI1-072	2	Housing cylinder
17	A1-SSI1-103	2	Piston for cylinder
18	A1-SSI1-074	1	Rack for pinion
19	A0-A079-032	2	Socket screw
	A0-A082-002	2	Spring washer.

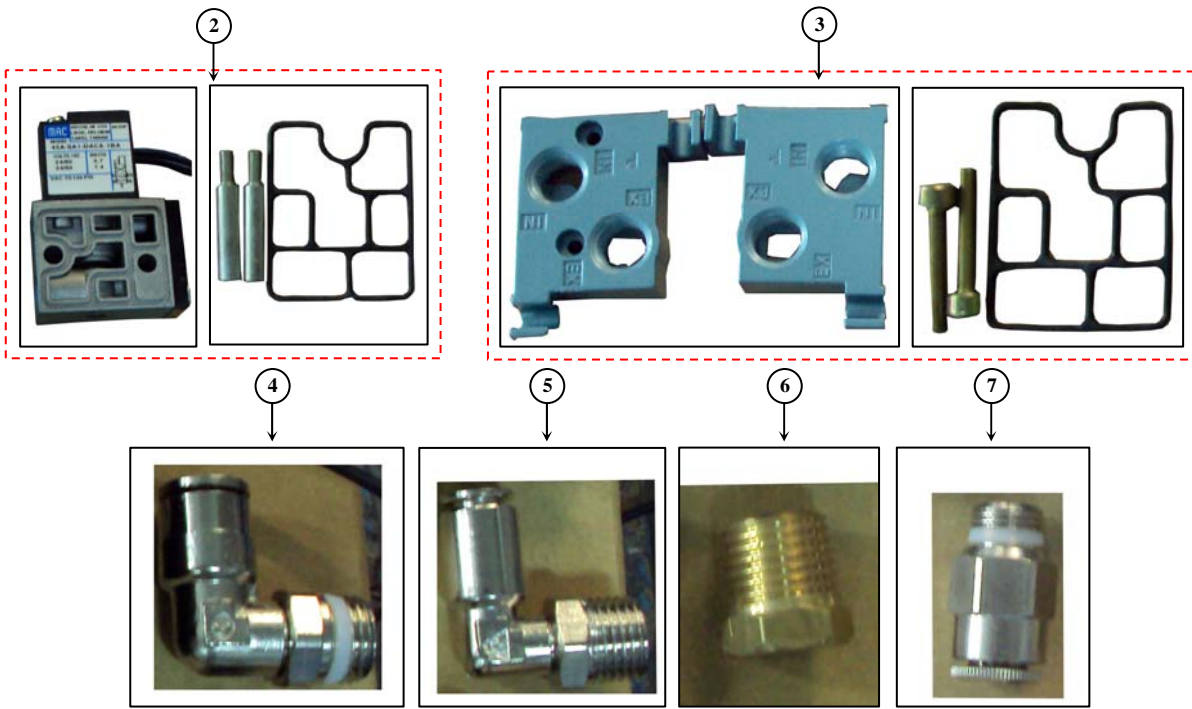
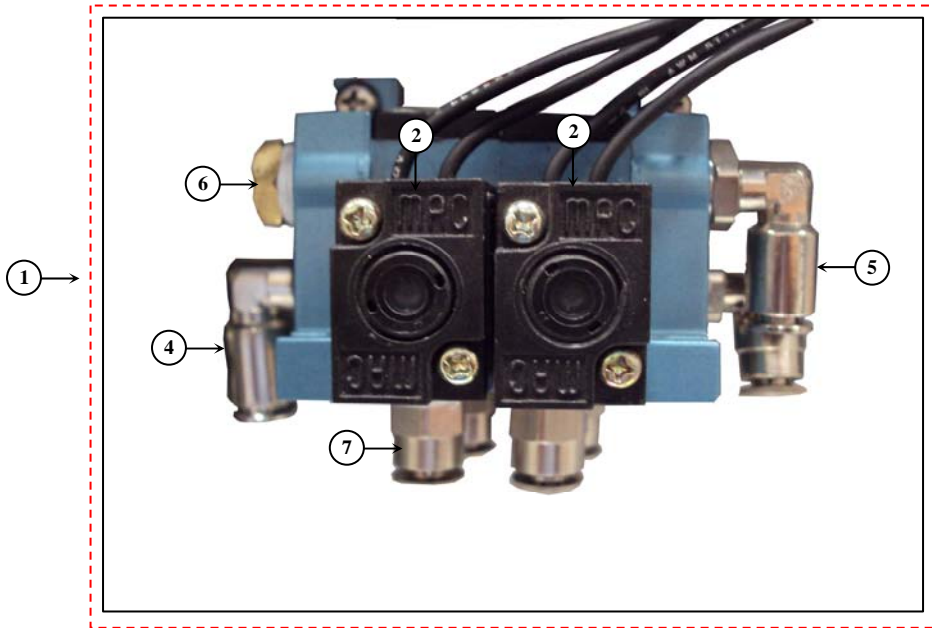

Item	Part No.	Qty.	Description
1	A1-S201-036	1	Air Solenoid Valve Assembly
2	A0-P005-006	2	Air Solenoid Valve
3	A0-P005-013	1	Valve Cover
4	A0-P006-004	1	Male Elbow 1/4", 8mm.
5	A0-P006-054	2	Male Elbow 1/4", 6mm.
6	A0-A105-002	1	Brass Plug 1/4"
7	A0-P006-074	4	Male Connector 1/4", 6 m.

